

contents

Product Overview	9/3
Manual Control	
Fractional HP Starters, Class SMF	9/4 - 9/5
Switches, Class MMS and MRS	9/6 - 9/7
Starters and Switches, Class 11 - 3RV	9/8 - 9/9
NEMA Control	
Catalog Numbering System	9/10
Non-Combination Starters Features and Benefits	9/11 - 9/12
Non-Reversing Starters, Class 14	9/13 - 9/15
Combination Starters Features and Benefits	9/16
Combination Starters, Class 17 and 18	9/17 - 9/25
Reversing Starters, Class 22	9/26 - 9/27
Combination Reversing Starters, Class 25 and 26	9/28 - 9/29
Two Speed Starters Features and Benefits	9/30
Two Speed Starters, Class 30	9/31 - 9/34
Combination Two Speed Starters, Class 32	9/35 - 9/42
Reduced Voltage Control	
Reduced Voltage Features and Benefits	9/43
Auto Transformer Starters, Class 36 and 37	9/44 - 9/47
Part Winding Starters, Class 36 and 37	9/48 - 9/51
Wye Delta Open Transition, Class 36 and 37	9/52 - 9/55
Wye Delta Closed Transition, Class 36 and 37	9/56 - 9/59
Heavy Duty Contactors	
Non-Reversing Contactors, Class 40	9/60 - 9/61
Vacuum Contactors,	9/60
Reversing Contactors, Class 43	9/62
Overload Relays	
Class 3UB8, 48, 958 and 3RB20	9/64 - 9/67
Duplex Controllers	
Features and Benefits	9/72
Non Combination, Class 83	9/73
Combination, Class 84	9/74 - 9/75
Pump Control Panels	
Slim Line NEMA Pump Controller for the Agricultural industry, Class 82	9/68 - 9/71
Class 87 and 88 Features and Benefits	9/76 - 9/77
Full-Voltage Type, Class 87	9/78 - 9/79
Vacuum Starter Type, Class 87	9/80
Reduced-Voltage Type, Class 88	9/81 - 9/82
Lighting Control	
Electrically Held Contactors, Class LE	9/83 - 9/88
Electrically Held Contactors, Class LC	9/89 - 9/93
Mechanically Held Contactors, Class CLM	9/94 - 9/96
Control Power Transformers	
Domestic and International (UL, CSA, CE) Class MT, MTG	9/97 - 9/101
Modifications and Drawings	
Field Modification Kits	9/102 - 9/112
Enclosure Kits	9/113 - 9/118
Factory Modifications	9/119 - 9/123
Dimensions	9/137 - 9/171
Wiring Diagrams	9/172 - 9/193

NEMA & General Purpose Controls

Controls Express

Starters at the speed you need

Siemens NEMA starters, pump panels and lighting contactors are known for their dependability and ruggedness, and now they are delivered faster than ever before through Controls Express.

Controls Express puts our most popular products in your hands faster, because we stock more products across our entire product line. Our Class 14 NEMA starters, Class 87 pump panels, and LC & LE lighting contactors are now available in stock for immediate or next day shipping. In addition, thousands of our open and enclosed starters can now be built-to-order and shipped in 1-3 days through Controls Express.

Siemens is committed to making your job easier by stocking more products, offering more configurations, expediting factory modifications, and delivering industry leading turnaround times on our most requested control products.

To quickly identify products that are part of Controls Express and therefore available in 3 days or less, applicable catalog numbers have a light blue background. See the appropriate selection pages listed below.

Class 14 NEMA Starters see pages 9/13 & 9/15

Class 17 NEMA Combination Starters see pages 9/17 to 9/22. For quick ship versions with factory modifications see on-line at www.usa.siemens.com/controls-express

Class 18 NEMA Combination Starters see pages 9/23 & 9/25.

Class 40 NEMA Contactors see page 9/60

Class 87 Pump Panels see pages 9/78 & 9/79

LE Lighting Contactors see page 9/85

LC Lighting Contactors see page 9/91 & 9/92



Controls Express lead times apply to orders of up to 6 units of the Class 14, Class 87, LC, or LE. Please contact customer service at 1-866-663-7324 for lead times of larger order volumes.

For more information on Controls Express and a complete list of available products, please visit our website at www.usa.siemens.com/controls-express

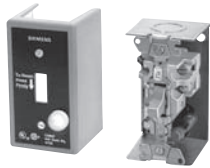

Class SMF
Fractional Horsepower
Manual Starters
Page 9/4

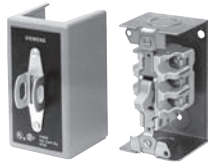

Class MMS & MRS
Fractional Horsepower
Manual Switches
Page 9/6



Class 11
Manual Starters and
Switches
Page 9/8



Class 14
NEMA Starters
Page 9/13



Class 17, 18
NEMA Combination
Starters
Page 9/17

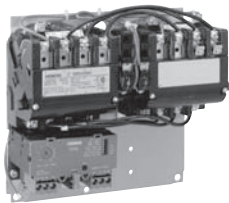

Class 22
NEMA Reversing
Starters
Page 9/26



Class 25, 26
NEMA Combination
Reversing Starters
Page 9/28

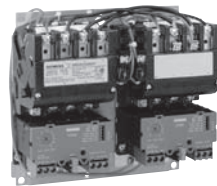

Class 30
NEMA Multi-Speed
Starters
Page 9/31



Class 32
NEMA Combination
Multi-Speed Starters
Page 9/35



Class 36, 37
Reduced Voltage
Electromechanical
Starters
Page 9/43



Class 40
NEMA Contactors
and Vacuum Contactors
Page 9/60

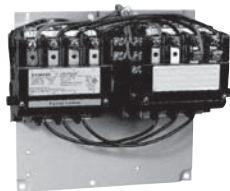

Class 43
NEMA Reversing
Contactors
Page 9/62



Class 48, 958, 3RB20
Overload Relays
Page 9/63



**Class 82, 83, 84,
87, 88**
Pump Controls
Page 9/68



Class LE, LC, CLM
Lighting Contactors
Page 9/83



Class MT, MTG
Control Power
Transformers
Page 9/97

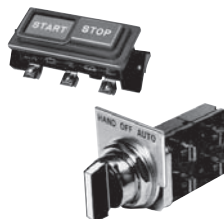

Modifications and
Drawings
Page 9/102

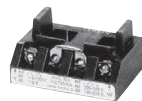

Heater Tables and
Replacement Parts
Page 9/124

Fractional HP Starters, Class SMF

General

Class SMF

Class SMF fractional horsepower starters provide overload protection as well as manual on-off control for small horsepower motors in a variety of industrial and commercial applications. Available in one or two pole versions, these devices are suitable for use with AC single phase motors up to 1 HP. Two pole starters can also be used with DC motors up to $\frac{3}{4}$ HP. Typical applications include fans, conveyors, pumps, and small machine tools.

Continuous Current Rating

16 amperes.

Overload Trip Assembly

Motor protection is provided by a Class SMFH heater element which must be installed before the starter will operate.

Two Speed Starters

Two speed manual starters are designed for control of small single phase AC motors having separate windings for high and low speed operation. Two toggle operated starters are used, with overload protection included for each motor winding. Surface mounting devices, and those with a gray flush plate, utilize a mechanical interlock which allows direct control of the motor by means of the toggle operators.

Enclosures

Class SMF, NEMA Type 1 surface mounting enclosures are sheet steel with a thermo-plastic wrap-around cover for convenience in wiring. The NEMA Type 1 enclosure is also available in an oversized version which allows more wiring space. A zinc alloy die casting is used for NEMA Type 4 enclosures.

Pilot Lights

Red or green neon pilot light units are available for flush mounting plates, NEMA Type 1 enclosures, and NEMA Type 4 enclosures. Pilot lights may be either factory or field installed. (For starters that contain a pilot light, a Red light is standard. For a Green pilot light add "G" to the end of the catalog number.)

Terminals

Binding head screw type terminals are suitable for #10 or smaller copper wire, and are accessible from the front. All terminals are clearly marked.

Mounting

Open types without a pilot light fit standard single gang switch boxes, and can be used with any cover plate having a standard toggle cutout. Single-unit flush mounting types, including those with pilot lights, are suitable for wall mounting in a standard switch box or for machine cavity mounting without a box.

Operation

Available with toggle handle or with removable key type operator to discourage unauthorized operation.

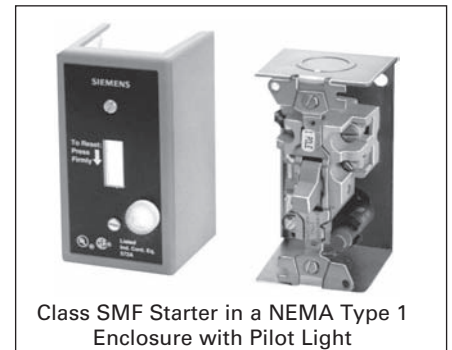

Class SMF Starter in a NEMA Type 1 Enclosure with Pilot Light

Emergency Off Actuator

A toggle operator extender is available for Class SMF, NEMA Type 1 surface mounted units. The extender has a red vinyl button that provides a fast and easy method for locating and switching the device's toggle operator into the OFF position. The Emergency Off Actuator is available in kit form only for field installation.

Handle Guard/Lock-Off

An optional handle guard on Class SMF, NEMA Type 1 enclosed starters prevents accidental operation of the toggle operator and also allows the toggle operator to be padlocked in either the "ON" or "OFF" position. This handle guard can be factory installed on NEMA Type 1 enclosed starters and is also available in kit form for field installation on NEMA Type 1 surface and flush mounting enclosures. Standard NEMA Type 4 metallic enclosures include provisions for padlocking the device in the OFF position.

Fractional HP Starters with Melting Alloy Overload, Class SMF

Selection

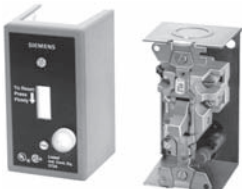
 <p>Class SMF Starter in a NEMA Type 1 Enclosure with Pilot Light</p>	Ordering Information		Horsepower Ratings		
	Heater Elements see page 9/124. Field Modification Kits see page 9/102. Dimensions see page 9/137. Wiring Diagrams see page 9/172.		Maximum Horsepower		
			AC Single Phase		DC
	Volts	1-Pole	2-Pole	2-Pole	
115	1	1	¾		
230	1	2	¾		
277	1	1	—		

Starter—Class SMF, Single Phase^①

Type of Operator	No. of Poles	Starter Features ^⑤	General Purpose Flush Mounting Open Starter with Flush Plate (No Enclosure Provided)						NEMA Type 1 General Purpose Enclosure, Surface Mounting		NEMA Type 3R, 4 & 12 Watertight, Dust-tight Metallic Enclosure with Clear Cover		NEMA Type 4 Watertight, Dust-tight Metallic Enclosure		NEMA Type 3R, 7 & 9 Div 1 and Div 2 Class I Groups B, C, D & Class II Groups E, F, G Enclosures			
			Open Type		Gray Flush Plate		Standard Stainless Steel Flush Plate		Jumbo Stainless Steel Flush Plate		Standard		Oversized		Catalog Number		List Price \$	
			Catalog Number	List Price \$	Catalog Number	List Price \$	Catalog Number	List Price \$	Catalog Number	List Price \$	Catalog Number	List Price \$	Catalog Number	List Price \$	Catalog Number	List Price \$	Catalog Number	List Price \$
Toggle	1	Standard	SMFF01	—	SMFFF1	—	SMFFS1	—	SMFFG1	—	SMFFGJ1	—	SMFFWN1	—	—	—	—	—
		Red Pilot Light	SMFF01P	—	SMFFF1P	—	SMFFS1P	—	SMFFG1P	—	SMFFGJ1P	—	SMFFWN1	—	—	—	—	—
Toggle	2	Standard	SMFF02	—	SMFFF2	—	SMFFS2	—	SMFFG2	—	SMFFGJ2	—	SMFFWN2	—	—	—	—	—
		Red Pilot Light	SMFF02P	—	SMFFF2P	—	SMFFS2P	—	SMFFG2P	—	SMFFGJ2P	—	SMFFWN2	—	—	—	—	—
Key	1	Standard	SMFF03	—	SMFFF3	—	SMFFS3	—	SMFFG3	—	SMFFGJ3	—	SMFFWN3	—	—	—	—	—
		Red Pilot Light	SMFF03P	—	SMFFF3P	—	SMFFS3P	—	SMFFG3P	—	SMFFGJ3P	—	SMFFWN3	—	—	—	—	—
Key	2	Standard	SMFF04	—	SMFFF4	—	SMFFS4	—	SMFFG4	—	SMFFGJ4	—	SMFFWN4	—	—	—	—	—
		Red Pilot Light	SMFF04P	—	SMFFF4P	—	SMFFS4P	—	SMFFG4P	—	SMFFGJ4P	—	SMFFWN4	—	—	—	—	—

Starter With Handle Guard/Lock-Off—Class SMF, Single Phase^①

Toggle	1	Standard	—	—	④	—	④	—	④	—	SMFFG5	—	SMFFGJ5	—	—	—	SMFFW1 ^②	SMFFR1 ^②
		Red Pilot Light	—	—	④	—	④	—	④	—	SMFFG5P	—	SMFFGJ5P	—	—	—	SMFFW1P ^②	SMFFR1P ^②
		(2) ¼" NPT Outlets	—	—	④	—	④	—	④	—	—	—	—	—	—	—	SMFFW1H	SMFFR1H
		(2) ¾" NPT Outlets and Red Pilot Light	—	—	④	—	④	—	④	—	—	—	—	—	—	—	SMFFW1PH	SMFFR1PH
Toggle	2	Standard	—	—	④	—	④	—	④	—	SMFFG6	—	SMFFGJ6	—	—	—	SMFFW2 ^②	SMFFR2 ^②
		Red Pilot Light	—	—	④	—	④	—	④	—	SMFFG6P	—	SMFFGJ6P	—	—	—	SMFFW2P ^②	SMFFR2P ^②
		(2) ¼" NPT Outlets	—	—	④	—	④	—	④	—	—	—	—	—	—	—	SMFFW2H	SMFFR2H
		(2) ¾" NPT Outlets and Red Pilot Light	—	—	④	—	④	—	④	—	—	—	—	—	—	—	SMFFW2PH	SMFFR2PH

One Starter in Duplex Enclosure—Class SMF, Single Phase^①

Type of Operator	Number of Poles	Starter Features ^⑤	General Purpose Flush Mounting Open Starter with Flush Plate - (No Enclosure Provided)				NEMA Type 1 General Purpose Enclosure Surface Mounting		Replacement Starters	
			Gray Flush Plate For Wall or Cavity Mounting		Stainless Steel Flush Plate for Wall or Cavity Mounting		Catalog Number		List Price \$	
			Catalog Number	List Price \$	Catalog Number	List Price \$	Catalog Number	List Price \$	Catalog Number	List Price \$
Toggle	2	Standard	—	—	—	—	SMFFG02	—	—	—
		Red Pilot Light	—	—	—	—	SMFFG02P	—	—	—
Key	2	Red Pilot Light	—	—	—	—	SMFFG04P	—	—	—

Two Starters In Duplex Enclosure—Class SMF, Single Phase^①

Toggle	2 Per Starter	Standard	SMFFF222	—	—	SMFFG222	—	—
		Red Pilot Light on Each Starter	SMFFF222P	—	—	SMFFG222P	—	—
Key	2 Per Starter	Red Pilot Light on Each Starter	SMFFF44P	—	—	SMFFS44P	—	—

Starter And "Auto-Off-Hand" SPDT Selector Switch (AC Only)—Class SMF, Single Phase^①

Toggle	1	Standard	SMFFF71	—	—	SMFFG71	—	—
		Red Pilot Light	SMFFF71P	—	—	SMFFS71P	—	—
Toggle	2	Standard	—	—	—	SMFFG72	—	—
		Red Pilot Light	SMFFF72P	—	—	SMFFS72P	—	—
Key	2	Red Pilot Light	SMFFF74P	—	—	SMFFS74P	—	—

Two Speed Starters (AC Only)—Class SMF, Single Phase^③

Toggle	1	Mechanical Interlock	SMFFF11	—	—	SMFFG11	—	SMFF01T
		Mechanical Interlock and (2) Red Pilot Lights	SMFFF11P	—	—	SMFFG11P	—	SMFF01PT
		Mechanical Interlock, HIGH-OFF-LOW Selector Switch and (2) Red Pilot Lights	—	—	—	—	—	SMFF01PT
	2	Mechanical Interlock	SMFFF22	—	—	SMFFG22	—	—
		Mechanical Interlock and (2) Red Pilot Lights	SMFFF22P	—	—	SMFFG22P	—	SMFF02PT
		Mechanical Interlock, HIGH-OFF-LOW Selector Switch and (2) Red Pilot Lights	—	—	SMFFS202P	—	—	SMFF02PT

① One heater element required.

② Furnished with (1) ¾" NPT Outlet in bottom (reversible for top feed).

③ Two heater elements required.

④ Order Open Type starter plus separate handle guard kit.

⑤ For starters that contain a pilot light, a Red light is standard. For a Green pilot light add "G" to the end of the catalog number.

Fractional HP Switches, Class MMS, MRS

General

Class MMS, MRS

Class MMS and MRS motor starting switches provide manual "ON-OFF" control of single or three phase AC motors where overload protection is not required or is provided separately. Compact construction and a 600 volt rating make these switches suitable for a wide range of industrial and commercial uses. Typical applications include small machine tools, pumps, fans, conveyors and many other types of electrical machinery. They can also be used on non-motor loads such as resistance heating applications.

Continuous Current Rating

MMS & MRS: 30 amperes at 250 volts max, 26.4 amperes at 277 volts, 20 amperes at 600 volts max, 30 amperes resistive at 600 volts max.

Two Speed—Class MRS

Two speed manual switches may be used with separate winding three phase or single phase AC motors where overload protection is not required or is provided separately. Two switches are employed to give "ON-OFF" control in each speed.

Reversing—Class MRS

Reversing manual switches provide a compact means of starting, stopping and reversing AC motors where overload protection is not required or is provided separately. They are suitable for use with three phase squirrel cage motors and for single phase motors which can be reversed by reconnecting motor leads. Two switches are used, one to connect the motor forward rotation and one for reverse.

Enclosures

Class MMS, MRS, NEMA Type 1 surface mounting enclosures are sheet steel with a thermo-plastic wrap-around cover for convenience in wiring. The NEMA Type 1 enclosure is also available in an oversized version which allows more wiring space. A zinc alloy die casting is used for NEMA Type 4 enclosures.

Pilot Lights

Red or green neon pilot light units are available for flush mounting plates, NEMA Type 1 enclosures, and NEMA Type 4 enclosures. Pilot lights may be either factory or field installed. (For switches that contain a pilot light, a Red light is standard. For a Green pilot light add "G" to the end of the catalog number.)

Terminals

Binding head screw type terminals are suitable for #10 or smaller copper wire, and are accessible from the front. All terminals are clearly marked.

Mounting

Open types without a pilot light fit standard single gang switch boxes, and can be used with any cover plate having a standard toggle cutout. Single-unit flush mounting types, including those with pilot lights, are suitable for wall mounting in a standard switch box or for machine cavity mounting without a box.

Operation

Available with toggle handle or with removable key type operator to discourage unauthorized operation.



Class MMS Switch in a NEMA Type 1 Enclosure

Emergency Off Actuator

A toggle operator extender is available for Class MMS, MRS, NEMA Type 1 surface mounted units. The extender has a red vinyl button that provides a fast and easy method for locating and switching the device's toggle operator into the OFF position. The Emergency Off Actuator is available in kit form only for field installation.

Handle Guard/Lock-Off

An optional handle guard on Class MMS, MRS, NEMA Type 1 enclosed switches prevents accidental operation of the toggle operator and also allows the toggle operator to be padlocked in either the "ON" or "OFF" position. This handle guard is available in kit form for field installation on NEMA Type 1 surface and flush mounting enclosures. Standard NEMA Type 4 metallic enclosures include provisions for padlocking the device in the OFF position.

Switches^①, Class MMS, MRS

Selection

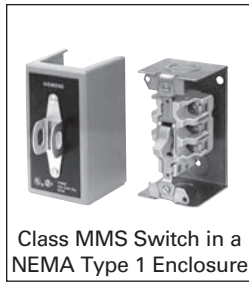

Ordering Information

Heater Elements not Required.
 Field Modification Kits see page 9/102.
 Dimensions see page 9/137.
 Wiring Diagrams see page 9/172.

Device		No of Poles	Motor Type AC	Maximum HP			DC Ratings		
				115V	230V	450–575V	90V	115V	230V
Class MMS	2	3	Single Phase	2	2	3	1	2	1 1/2
	3		3-Phase	2	7 1/2	10	1	2	1 1/2
Class MRS Reversing	2	3	Single Phase	2	2	3	1	2	1 1/2
	3		3-Phase	2	7 1/2	10	1	2	1 1/2
Class MMS Two Speed	2	3	Single Phase	2	2	3	1	2	1 1/2
	3		3-Phase, Constant or Variable Torque	2	7 1/2	10	1	2	1 1/2
			3-Phase, Constant Horsepower	2	7 1/2	10	1	2	1 1/2

Switch—Class MMS, Single Phase and 3-Phase

Type of Operator	No of Poles	Switch Features ^④	General Purpose Flush Mounting Open Switch with Flush Plate (No Enclosure Provided)				NEMA Type 1 General Purpose Enclosure Surface Mounting				NEMA Type 3R, 4 & 12 Watertight, Dust-tight Metallic Enclosure with Clear Cover	NEMA Type 4 ^⑤ Watertight, Dust-tight Metallic Enclosure	NEMA Type 7 & 9 ^⑥ Class I Groups B, C & D & Class II Groups E, F, G Enclosures						
			Open Type		Gray Flush Plate	Standard Stainless Steel Flush Plate	Jumbo Stainless Steel Flush Plate	Standard		Overized									
			Catalog Number	List Price \$	Catalog Number	List Price \$	Catalog Number	List Price \$	Catalog Number	List Price \$	Catalog Number	List Price \$	Catalog Number	List Price \$	Catalog Number	List Price \$	Catalog Number	List Price \$	
Toggle	2	Standard	MMSK01		MMSKF1		MMSKS1		—		MMSKG1		—		MMSKWN1		MMSKW1		MMSKR1
		Red Pilot Light 115V AC	MMSK01A ^③		MMSKF1A		MMSKS1A		—		MMSKG1A		MMSKGJ1A		—		MMSKW1A		—
	Red Pilot Light 230V AC	MMSK01B ^③		MMSKF1B		MMSKS1B		MMSKSJ1B		MMSKG1B		—				MMSKW1B		—	
	3	Standard	MMSK02		MMSKF2		MMSKS2		—		MMSKG2		MMSKGJ2		MMSKWN2		MMSKW2		MMSKR2
		Red Pilot Light 208–240V AC	MMSK02B ^③		MMSKF2B		MMSKS2B		—		MMSKG2B		MMSKGJ2B				MMSKW2B		—
		Red Pilot Light 440–600V AC	MMSK02C ^③		—		MMSKS2C		MMSKSJ2C		MMSKG2C		MMSKGJ2C				MMSKW2C		—
Key	2	Standard	MMSK03		MMSKF3		MMSKS3		—		MMSKG3		MMSKGJ3		MMSKWN3		—		—
		Red Pilot Light 115V AC	—		MMSKF3A		MMSKS3A		MMSKSJ3A		MMSKG3A		MMSKGJ3A				—		—
		Red Pilot Light 230V AC	MMSK03B		MMSKF3B		MMSKS3B		MMSKSJ3B		MMSKG3B		MMSKGJ3B				—		—
	3	Standard	MMSK04		MMSKF4		MMSKS4		—		MMSKG4		MMSKGJ4		MMSKWN4		—		—
		Red Pilot Light 208–240V AC	MMSK04B		MMSKF4B		MMSKS4B		MMSKSJ4B		MMSKG4B		MMSKGJ4B				—		—
		Red Pilot Light 440–600V AC	MMSK04C		MMSKF4C		MMSKS4C		MMSKSJ4C		MMSKG4C		MMSKGJ4C				—		—

Reversing Switch—Class MRS, Single Phase and 3-Phase

Type of Operator	Number of Poles	Suitable Motor Types	Switch Features ^④ (Including Mechanical Interlock)	General Purpose Flush Mounting Open Switch with Flush Plate (No Enclosure Provided)		NEMA Type 1 General Purpose Enclosure Surface Mounting		Replacement Switch Class MRS	
				Catalog Number	List Price \$	Catalog Number	List Price \$	Catalog Number	List Price \$
Toggle	2	Single Phase 3-Lead Repulsion-Induction	Standard	MRSKF11		—		MRSK01T	
			Red Pilot Device—115V AC	MRSKF11A		—		MRSK01AT	
			Red Pilot Device—230V AC	MRSKF11B		MRSKG11B		MRSK01BT	
	3	3-Phase; Also Single Phase Capacitor, Split Phase, or 4-Lead Repulsion-Induction	Standard	MRSKF22		MRSKG22		—	
			Red Pilot Light—110–120V AC	MRSKF22A		MRSKG22A		MRSK02AT	
			Red Pilot Light—208–220V AC	MRSKF22B		—		MRSK02BT	
	Red Pilot Light—440–600V AC	MRSKF22C		MRSKG22C		MRSK02CT			

Two Speed Switch—Class MMS, Single Phase and 3-Phase

Type of Operator	Number of Poles	Suitable Motor Types	Switch Features ^④ (Including Mechanical Interlock)	General Purpose Flush Mounting Open Switch with Flush Plate (No Enclosure Provided)		NEMA Type 1 General Purpose Enclosure Surface Mounting		Replacement Switch Class MRS	
				Catalog Number	List Price \$	Catalog Number	List Price \$	Catalog Number	List Price \$
Toggle	2	Single Phase Two Winding (3-Lead)	Standard	MMSKF11		MMSKG11		MRSK01T	
			(2) Red Pilot Devices—115V AC	MMSKF11A		MMSKG11A		MRSK01AT	
			(2) Red Pilot Devices—230V AC	MMSKF11B		MMSKG11B		MRSK01BT	
	3	3-Phase Separate Winding (Wye-Connected)	Standard	MMSKF22		MMSKG22		MRSK02T	
			(2) Red Pilot Lights—208–240V AC	MMSKF22B		MMSKG22B		MRSK02BT	
			(2) Red Pilot Lights—440–600V AC	MMSKF22C		MMSKG22C		MRSK02CT	

① Manual switches do not include overloads.
 ② Furnished with (1) 3/4" NPT outlet in bottom (reversible for top feed). In order to obtain a 3/4" NPT outlet in top and bottom, add suffix letter "H" to type number with List Price adder.
 ③ Do not use as replacement interiors for NEMA Type 4 metallic enclosures. For replacement unit, order Type MMSK01 or MMSK02 and separate pilot light kit.
 ④ For switches that contain a pilot light, a Red light is standard. For a Green pilot light add "G" to the end of the catalog number.

Now Available with the New 3RV2 Innovations MSP

Class 11 - 3RV

Class 11 across the line manual starters and switches provide control for machinery where remote start stop control is not required.

Class 11 - 3RV manual starters are used for single and poly-phase motors up to 20HP @ 575V. Starters have bimetallic heater elements to provide class 10 overcurrent protection. Each starter has a fourth bimetallic strip that reacts only to the ambient temperature inside the control panel. This ambient compensation helps prevent the starter from nuisance tripping when the panel temperature is higher than the ambient temperature of the motor.

A built-in differential trip bar causes the starter to trip faster on a phase loss condition to help reduce motor damage.

Magnetic trip elements in each starter take the device off line when it senses current of 13 times the maximum FLA dial setting.

Class 11 - 3RV switches provide control for inherently protected motors. Typical applications include metal and woodworking machinery, grinders, power saws, conveyors, fans, pumps, blowers, textile and packaging machinery, and paper cutters.

Each switch is provided with magnetic trip elements which take the device off line when it senses current of 13 times the maximum switch rating.

Class 11 - 3RV manual starters can be used as Type E self-protected manual combination starters (up to 22 amps) per UL508 or as components in Group Installation per NEC 430.53. When using the Class 11 - 3RV as a manual combination starter upstream protection is not required.

Class 11 - 3RV controllers are available with low voltage protection which will automatically open the power poles when the voltage drops or the power is interrupted.

Controllers with the LVP option provide the OSHA requirements for protecting personnel from potential injury caused by the automatic start-up of machinery following a voltage drop or power interruption when low voltage protection is specified.

Class 11 - 3RV is available as Open style, or in NEMA 1, NEMA 7 & 9 or NEMA 7 & 9 / 3 & 4 enclosures.

Standard Features include:

- ON/OFF rotary handle with lockout and visible trip indication
- Adjustment dial for setting to motor FLA (Starters only)
- Low Voltage Protection (LVP) Option
- Short Circuit trip at 13 times the maximum setting of the FLA dial or rated current
- Ambient compensated up to 140°F
- Phase loss sensitivity
- Test trip function
- LVP Option Meets OSHA Requirements
- UL Listed
- CSA Certified

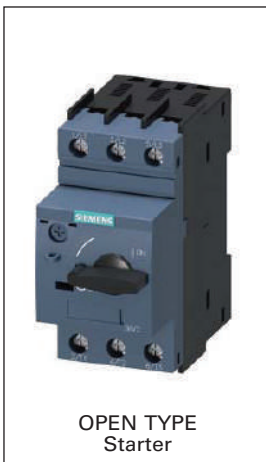

OPEN TYPE Starter



NEMA 1 General Purpose



NEMA 7 & 9 Div 1 & Div 2 Class I Group C & D Class II Group E, F & G

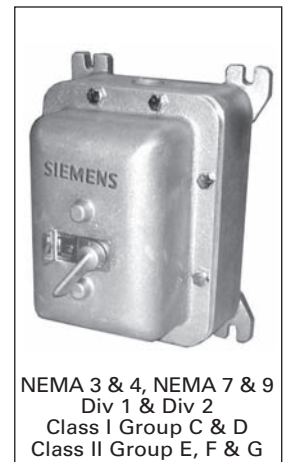

NEMA 3 & 4, NEMA 7 & 9 Div 1 & Div 2 Class I Group C & D Class II Group E, F & G

Starters and Switches, Class 11 - 3RV

Selection

 <p>Class 11 Manual Motor Starter</p>	<p>Ordering Information</p> <p>No heaters required. Field Modification Kits see page 9/102. Dimensions see page 9/139. Wiring Diagrams see page 9/172. For applications requiring a low voltage protection coil see table at right.</p>	<p>Low Voltage Protection Coil Table</p> <table border="1"> <thead> <tr> <th>60 Hz Voltage</th> <th>Letter</th> </tr> </thead> <tbody> <tr> <td>120V</td> <td>*F</td> </tr> <tr> <td>208V</td> <td>*D</td> </tr> <tr> <td>240V</td> <td>*G</td> </tr> <tr> <td>460V</td> <td>*H</td> </tr> </tbody> </table> <p>*Add corresponding letter to end of base Class 11 catalog number for low voltage protection coil with List Price adder.</p> <p>Note: The LVP option for Open type 3RV is available from the factory, please order separately from the field modification kits on page 9/103.</p> <p>The coil voltage should correspond with the line voltage.</p>	60 Hz Voltage	Letter	120V	*F	208V	*D	240V	*G	460V	*H
	60 Hz Voltage	Letter										
120V	*F											
208V	*D											
240V	*G											
460V	*H											

Manual Starter—Class 11 - 3RV

FLA Adjustment Range ^①	Max HP						Enclosure							
	Single Phase HP Ratings		3-Phase HP Ratings				Open Type		NEMA 1 General Purpose		NEMA 7 & 9 Class I Groups C & D Class II Groups E, F & G		NEMA 3 & 4, NEMA 7 & 9 Watertight Class I Groups C & D Class II Groups E, F & G	
	115V	230V	200V	230V	460V	575V	Catalog No.	List Price \$	Catalog No.	List Price \$	Catalog No.	List Price \$	Catalog No.	List Price \$
0.11-0.16	—	—	—	—	—	—	3RV2011-0AA10 ^②		11AD3B		11AD3H		11AD3W	
0.14-0.2	—	—	—	—	—	—	3RV2011-0BA10 ^②		11BD3B		11BD3H		11BD3W	
0.18-0.25	—	—	—	—	—	—	3RV2011-0CA10 ^②		11CD3B		11CD3H		11CD3W	
0.22-0.32	—	—	—	—	—	—	3RV2011-0DA10 ^②		11DD3B		11DD3H		11DD3W	
0.28-0.4	—	—	—	—	—	—	3RV2011-0EA10 ^②		11ED3B		11ED3H		11ED3W	
0.35-0.5	—	—	—	—	—	—	3RV2011-0FA10 ^②		11FD3B		11FD3H		11FD3W	
0.45-0.63	—	—	—	—	—	—	3RV2021-0GA10 ^②		11GD3B		11GD3H		11GD3W	
0.55-0.8	—	—	—	—	—	½	3RV2021-0HA10 ^②		11HD3B		11HD3H		11HD3W	
0.7-1	—	—	—	—	½	½	3RV2021-0JA10 ^②		11JD3B		11JD3H		11JD3W	
0.9-1.25	—	—	—	—	¾	¾	3RV2021-0KA10 ^②		11KD3B		11KD3H		11KD3W	
1.1-1.6	—	⅓	—	—	¾	1	3RV2021-1AA10 ^②		11LD3B		11LD3H		11LD3W	
1.4-2	—	⅓	—	—	1	1 ½	3RV2021-1BA10 ^②		11MD3B		11MD3H		11MD3W	
1.8-2.5	—	⅓	½	½	1 ½	1 ½	3RV2021-1CA10 ^②		11ND3B		11ND3H		11ND3W	
2.2-3.2	⅓	⅓	¾	¾	1 ½	2	3RV2021-1DA10 ^②		11PD3B		11PD3H		11PD3W	
2.8-4	⅓	⅓	¾	1	2	3	3RV2021-1EA10 ^②		11QD3B		11QD3H		11QD3W	
3.5-5	⅓	½	1	1	3	3	3RV2021-1FA10 ^②		11RD3B		11RD3H		11RD3W	
4.5-6.3	¼	¾	1 ½	1 ½	5	5	3RV2021-1GA10 ^②		11SD3B		11SD3H		11SD3W	
5.5-8	⅓	1	2	2	5	5	3RV2021-1HA10 ^②		11TD3B		11TD3H		11TD3W	
7-10	⅓	1 ½	3	3	7 ½	10	3RV2021-1JA10 ^②		11UD3B		11UD3H		11UD3W	
9-12.5	⅓	2	3	3	7 ½	10	3RV2021-1KA10 ^②		11VD3B		11VD3H		11VD3W	
11-16	1	3	5	5	10	15 ^③	3RV2021-4AA10 ^②		11WD3B		11WD3H		11WD3W	
14-20	1 ½	3	5	7 ½	15	20 ^③	3RV2021-4BA10 ^②		11XD3B		11XD3H		11XD3W	
17-22	2	3	7 ½	7 ½	15	20 ^③	3RV2021-4CA10 ^②		11YD3B		11YD3H		11YD3W	
20-25	2 ^③	5 ^③	7 ½ ^③	7 ½ ^③	15 ^③	20 ^③	3RV2021-4DA10 ^②		11ZD3B		11ZD3H		11ZD3W	

Manual Switch—Class 11 - 3RV

Rated Current ^①	Max HP						Enclosure							
	Single Phase HP Ratings		3-Phase HP Ratings				Open Type		NEMA 1 General Purpose		NEMA 7 & 9 Class I Groups C & D Class II Groups E, F & G		NEMA 3 & 4, NEMA 7 & 9 Watertight Class I Groups C & D Class II Groups E, F & G	
	115V	230V	200V	230V	460V	575V	Catalog No.	List Price \$	Catalog No.	List Price \$	Catalog No.	List Price \$	Catalog No.	List Price \$
1	—	—	—	—	½ ^③	½ ^③	3RV2321-0JC10 ^②		111D3B		111D3H		111D3W	
5	⅓ ^③	½ ^③	1 ^③	1 ^③	3 ^③	3 ^③	3RV2321-1FC10 ^②		112D3B		112D3H		112D3W	
10	½ ^③	1 ½ ^③	3 ^③	3 ^③	7 ½ ^③	10 ^③	3RV2321-1JC10 ^②		113D3B		113D3H		113D3W	
20	1 ½ ^③	3 ^③	5 ^③	7 ½ ^③	15 ^③	20 ^③	3RV2321-4BC10 ^②		114D3B		114D3H		114D3W	
25	2 ^③	5 ^③	7 ½ ^③	7 ½ ^③	15 ^③	20 ^③	3RV2321-4DC10 ^②		115D3B		115D3H		115D3W	

① Instantaneous Magnetic Trip will occur at 13 times the maximum FLA dial setting or rated switch current.
 ② Product Category: IEC

③ Shaded Ratings apply for Manual Motor Controllers Only! These Ratings do not apply as UL Listed Manual Combination Starters.

④ Add 1 to the end of the catalog number for 1/2 inch drain hole with plug and list price adder. Drain fitting not supplied, order separately XDB-2.

Catalog Numbering System

General

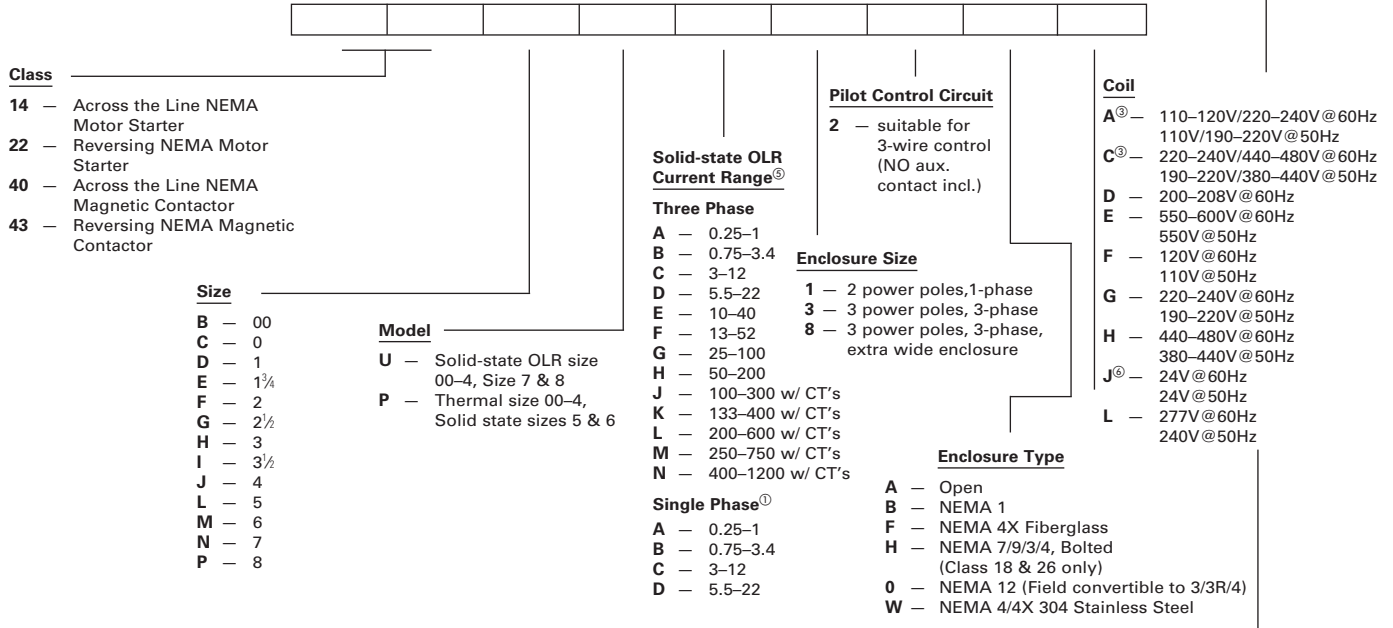
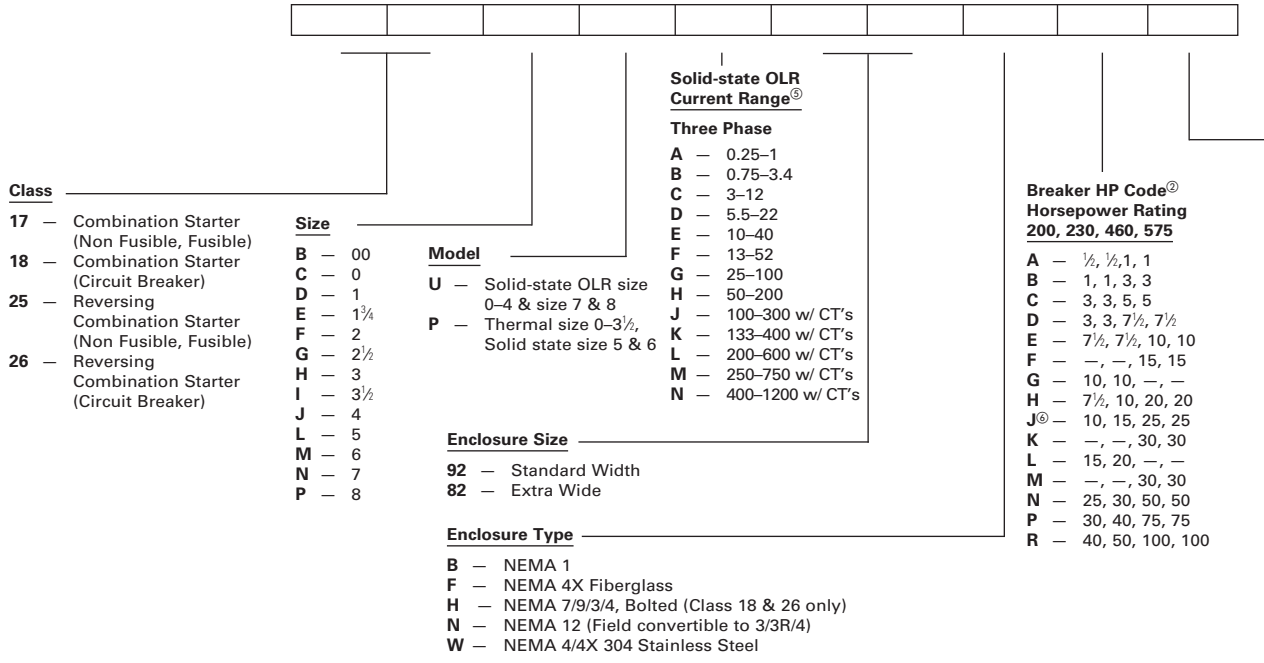

Class	Size	Model	Solid-state OLR Current Range ^③	Type	Line Volts	Enclosure Type	Coil	Disconnect Type ^④
36 - Non Combination Reduced Voltage Starter	C - 0	U - Solid-state OLR size 0-4 & size 7 & 8 P - Thermal size 0-3 1/2 Solid state size 5 & 6		T - Auto XFMR	2 - 230	A - Open	D	D - Non Fused Disc.
	D - 1			P - Part Wind.	3 - 380	B - NEMA 1	E	F - Fusible Disc.
	E - 1 3/4			0 - Wye Delta Open Trans.	4 - 460	W - NEMA 4/4X Stainless Steel	F	P - MCP
	F - 2			C - Wye Delta Closed Trans.	5 - 575	0 - NEMA 12	G	
	G - 2 1/2				6 - 200/208		H	
	H - 3						L	
37 - Combination Reduced Voltage Starter	I - 3 1/2							
	J - 4							
	L - 5							
	M - 6							
	N - 7							
	P - 8							

① Single phase solid-state OLR available on Class 14 Starters only. ② Not used on Class 17, 25 or with solid-state OLR versions. ③ Position used for solid-state OLR only.
 ④ Not available on sizes 5-8. ⑤ Not available on sizes 7 and 8. ⑥ For Class 37 only.

GENERAL PURPOSE CONTROL 9

Features and Benefit

General



Solid State Starter Class 14

Standard Features

Size 00–4 magnetic starters include the following standard features:

- Rugged Industrial Design
- Half Sizes for Cost and Space Savings
- Dual Voltage, Dual Frequency Coils
- Solid State or Ambient Compensated Bimetal Overload Protection
- Wide Range of Accessories
- Easy Coil Access
- Overload Test Feature
- Straight Thru Wiring
- Gravity Dropout
- Large Silver Cadmium Contacts
- UL listed file #E14900 (class 14, 22, 30, 40 & 43)
- CSA certified file #LR 6535 (class 14, 22, 30, 40 & 43)

Application

Heavy Duty starters are designed for across the line starting of single phase and polyphase motors.

These controls are available in NEMA Sizes 00 through 8. In addition to the usual NEMA Starter Sizes, Siemens offers three exclusive Half Sizes; 1¾, 2½ and 3½. These integral sizes offer the same rugged, industrial construction as our NEMA Sizes and ensure efficient operating performance. Half Sizes provide a real cost savings by cutting down on over capacity when NEMA Sizes exceed the motor ratings. All Siemens Heavy Duty controls, including our popular Half Sizes comply with applicable NEMA and UL tests.

All starters are supplied with a NO holding interlock that in conjunction with an appropriate pilot device will provide low voltage protection or release.

NEMA starters are ideal for applications requiring dependability and durability. Typical applications include use with machine tools, air conditioning equipment, material handling equipment, compressors, hoists and various production and industrial equipment as well as in demanding automotive applications.

Starters are available as an open type or in NEMA 1, 12/3/3R, 4 (painted), 4/4X (stainless), 4X (fiberglass), and 7 & 9 enclosures.

Gravity Dropout

For added reliability, the gravity dropout of the armature and contacts is assisted by stainless steel springs which help provide quick, precise opening of the contacts.

45 Degree, Wedge Action Contacts

The 45 degree, wedge action contacts reduce tracking and provide faster arc quenching. The resulting self-cleaning and reduced contact bounce mean cooler operation and longer life for the large silver cadmium oxide contacts.

Terminal Design

Control terminals are self-rising pressure type.

Molded Coil

Magnetic coils are carefully wound and then sealed in epoxy. Encapsulation helps seal out moisture, promotes heat transfer and resists electrical, mechanical and thermal stresses.

Dual Voltage/Frequency Coil

Starters are available with dual voltage, dual frequency coils. They are designed to operate on either 50 or 60 Hertz.

Molded Stationary Contact Block

Thermoset materials resist arc tracking and the stresses of heat and severe impact.

Field Modification Kits

All starters can be modified in the field with a complete range of accessories. These include pushbuttons, selector switches, pilot lights, auxiliary contacts and surge suppressors.

Auxiliary Equipment

- NEMA starters are available with built-in START-STOP push buttons for 3-wire control or a HAND-OFF-AUTO selector switch for 2-wire control
- Field modifications such as auxiliary contacts, pilot lights, push buttons, selector switches, and fuse blocks are available to meet particular application requirements
- Normally opened or normally closed auxiliary power pole kits are available for Sizes 00 through 1¾
- Transformers can be ordered as either factory or field modifications. In some cases these may require a larger enclosure
- A full line of replacement parts are available including contact kits, coils, and overload relays

Size 5 & 6 Starters Additional Features

- Solid State Overload (3RB type) Standard
- Latest technology in arc quenching to extend contactor life
- Wide variety of enclosures in all starter configurations

Size 7 & 8 Starters Additional Features

- New Compact Design
- Can be mounted in any position
- Same coil voltage is AC or DC

Features and Benefits

Selection



ESP200™ Solid State Starter

ESP200™ starters combine the rugged NEMA contactors with a state of the art solid state overload that provides phase loss, phase unbalance ground fault protection. It offers the user greater motor protection and extended life in heavy duty applications. The ESP200™ ultimately results in a cost savings to the user.

ESP200™ Solid State Overload Relays

Standard features provide Improved Starter Performance:

- True phase loss protection; trips within 3 seconds
- Phase unbalanced prevents motor running inefficiently
- Ground fault trip when selected
- Selectable trip class 5, 10, 20 or 30
- Reset trip can be selected Auto/Manual restart
- Easy to select and use, Dip Switch selectable
- Overload is self powered, no need for external power source

Half Size Starters

Half-Size starters feature all the rugged performance characteristics of our NEMA rated starter sizes, but are fractionally sized to more closely match your exact motor rating. As a result, significant economic savings are made possible without sacrificing the reliability you expect from a heavy duty starter.

These additional starter sizes have the reserve capacity to handle occasional plugging and jogging applications without derating. Superior operating performance in heavy duty applications is assured by the large current carrying parts, not by derating the device.

Exclusive “half-sizes” save potentially hundreds, even thousands of dollars per project.

Using the table below, simply match the specific size starter to the horsepower rating of your motor. Every half-size starter saves you money—up to 31%.

All “half-sizes” comply to applicable NEMA and UL standards.

ESP200® FLA Adjustment Dial—Set the adjustment dial on the overload to the FLA of the motor.

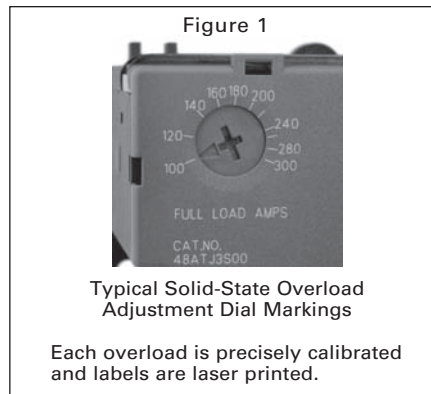

Typical Solid-State Overload Adjustment Dial Markings

Each overload is precisely calibrated and labels are laser printed.



DIP Switch Settings

Adjust DIP switch settings to the Trip Class desired 5, 10, 20, or 30.

- Set Phase Unbalance ON or OFF
- Set Phase Loss ON or OFF
- Set Reset to Manual or Automatic
- Set Ground Fault ON or OFF

Savings for Siemens “Half-Size” Starters in NEMA 1 Enclosures, FVNR

Motor Size	230V	460V	Starter Size	Half Size	List Price \$	“Half-Size” Savings Over Next Full Size
7½	10	—	1	—	—	—
10	15	—	—	1¾	—	31%
15	25	—	2	—	—	—
20	30	—	—	2½	—	20%
30	50	—	3	—	—	—
40	75	—	—	3½	—	13%
50	100	—	4	—	—	—

Standard Auxiliary Contacts			
Type	Size (3rd Character)	Configuration	Internal / External
All FVNR Starters & Contactors	B Thru E	1N.O.	Internal
	F Thru J	1N.O.	External
	L Thru M	2N.O., 2N.C.	External
	N Thru P	1N.O., 1N.C.	External

Solid State Overload with Auto/Manual Reset, Class 14

Selection



Ordering Information

Replace the (*) with a letter from the coil table. Dual voltage coils are wired on high voltage unless specified on order.
 Field Modification Kits see page 9/104.
 Factory Modifications see page 9/119.
 Dimensions see pages 9/140 open and 9/157 enclosed.
 Wiring Diagrams see page 9/173.
 Replacement Parts see page 9/131.

Coil Table

60Hz Voltage	Letter
24	J
120	F
110-120/220-240 [Ⓛ]	A
200-208	D
220-240	G
277	L
220-240/440-480 [Ⓛ]	C
440-480	H
575-600	E

For other voltages and frequencies, see Factory Modifications page 9/119.

Open Type & Standard Width Enclosure, 3-Phase, 3-Pole

Max Hp					Overload		Enclosure														
200 Volts	230 Volts	460 Volts	575 Volts	NEMA Size	Half Size	Amp Range	Frame Size	Open Type Standard Auxiliary Contacts [Ⓛ]		NEMA 1 General Purpose		NEMA 4/4X Stainless [Ⓛ] Watertight, Dust-tight, Corrosion Resistant Ⓛ = W for 304 Stainless Steel Ⓛ = X for 316 Stainless Steel		NEMA 4X Fiberglass Watertight, Dust-tight Corrosion Resistant		NEMA 7 & 9 NEMA 3 & 4 Div. 1 and Div. 2 Class I Groups C & D Class II Groups E, F & G Class III Bolted Enclosures Indoor/Outdoor Use		NEMA 12 NEMA 3/3R [Ⓛ] Industrial Use Weatherproof (Field Convertible to 3/3R)			
Catalog Number	List Price \$	Catalog Number	List Price \$	Catalog Number	List Price \$	Catalog Number	List Price \$	Catalog Number	List Price \$	Catalog Number	List Price \$	Catalog Number	List Price \$	Catalog Number	List Price \$	Catalog Number	List Price \$	Catalog Number	List Price \$	Catalog Number	List Price \$
1/2	1/2	1/2	1/2	00	—	0.25-1	A	14BUA32A*	14BUB32A*	14BUC32A*	14BUC32B*	14BUC32B*	14BUC32B*	14BUC32B*	14BUC32B*	14BUC32B*	14BUC32B*	14BUC32B*	14BUC32B*	14BUC32B*	14BUC32B*
1/2	3/4	1 1/2	2	00	—	0.75-3.4	A	14BUB32A*	14BUB32B*	14BUC32A*	14BUC32B*	14BUC32B*	14BUC32B*	14BUC32B*	14BUC32B*	14BUC32B*	14BUC32B*	14BUC32B*	14BUC32B*	14BUC32B*	14BUC32B*
1 1/2	1 1/2	2	—	00	—	3-12	A1	14BUC32A*	14BUC32B*	14BUC32B*	14BUC32B*	14BUC32B*	14BUC32B*	14BUC32B*	14BUC32B*	14BUC32B*	14BUC32B*	14BUC32B*	14BUC32B*	14BUC32B*	14BUC32B*
1/2	3/4	1 1/2	2	0	—	0.25-1	A	14CUA32A*	14CUB32A*	14CUC32A*	14CUC32B*	14CUC32B*	14CUC32B*	14CUC32B*	14CUC32B*	14CUC32B*	14CUC32B*	14CUC32B*	14CUC32B*	14CUC32B*	14CUC32B*
1/2	3/4	1 1/2	2	0	—	0.75-3.4	A	14CUB32A*	14CUB32B*	14CUC32A*	14CUC32B*	14CUC32B*	14CUC32B*	14CUC32B*	14CUC32B*	14CUC32B*	14CUC32B*	14CUC32B*	14CUC32B*	14CUC32B*	14CUC32B*
2	2	5	5	0	—	3-12	A1	14CUC32A*	14CUC32B*	14CUC32B*	14CUC32B*	14CUC32B*	14CUC32B*	14CUC32B*	14CUC32B*	14CUC32B*	14CUC32B*	14CUC32B*	14CUC32B*	14CUC32B*	14CUC32B*
3	3	—	—	0	—	5.5-22	A1	14CUD32A*	14CUD32B*	14CUD32B*	14CUD32B*	14CUD32B*	14CUD32B*	14CUD32B*	14CUD32B*	14CUD32B*	14CUD32B*	14CUD32B*	14CUD32B*	14CUD32B*	14CUD32B*
1/2	3/4	1 1/2	2	1	—	0.25-1	A	14DUA32A*	14DUB32A*	14DUC32A*	14DUD32A*	14DUE32A*	14DUE32B*	14DUE32B*	14DUE32B*	14DUE32B*	14DUE32B*	14DUE32B*	14DUE32B*	14DUE32B*	14DUE32B*
1/2	3/4	1 1/2	2	1	—	0.75-3.4	A	14DUB32A*	14DUB32B*	14DUC32A*	14DUD32A*	14DUE32A*	14DUE32B*	14DUE32B*	14DUE32B*	14DUE32B*	14DUE32B*	14DUE32B*	14DUE32B*	14DUE32B*	14DUE32B*
2	2	5	5	1	—	3-12	A1	14DUC32A*	14DUC32B*	14DUC32B*	14DUD32A*	14DUE32A*	14DUE32B*	14DUE32B*	14DUE32B*	14DUE32B*	14DUE32B*	14DUE32B*	14DUE32B*	14DUE32B*	14DUE32B*
3	3	10	10	1	—	5.5-22	A1	14DUD32A*	14DUD32B*	14DUD32B*	14DUD32B*	14DUE32A*	14DUE32B*	14DUE32B*	14DUE32B*	14DUE32B*	14DUE32B*	14DUE32B*	14DUE32B*	14DUE32B*	14DUE32B*
7 1/2	7 1/2	—	—	1	—	10-40	A1	14DUE32A*	14DUE32B*	14DUE32B*	14DUE32B*	14DUE32B*	14DUE32B*	14DUE32B*	14DUE32B*	14DUE32B*	14DUE32B*	14DUE32B*	14DUE32B*	14DUE32B*	14DUE32B*
10	10	15	15	—	1 1/2	10-40	A1	14EUE32A*	14EUE32B*	14EUE32B*	14EUE32B*	14EUE32B*	14EUE32B*	14EUE32B*	14EUE32B*	14EUE32B*	14EUE32B*	14EUE32B*	14EUE32B*	14EUE32B*	14EUE32B*
10	15	25	25	2	—	13-52	B	14FUF32A*	14FUF32B*	14FUF32B*	14FUF32B*	14FUF32B*	14FUF32B*	14FUF32B*	14FUF32B*	14FUF32B*	14FUF32B*	14FUF32B*	14FUF32B*	14FUF32B*	14FUF32B*
15	20	30	30	—	2 1/2	25-100	B	14GUG32A*	14GUG32B*	14GUG32B*	14GUG32B*	14GUG32B*	14GUG32B*	14GUG32B*	14GUG32B*	14GUG32B*	14GUG32B*	14GUG32B*	14GUG32B*	14GUG32B*	14GUG32B*
25	30	50	50	3	—	25-100	B	14HUG32A*	14HUG32B*	14HUG32B*	14HUG32B*	14HUG32B*	14HUG32B*	14HUG32B*	14HUG32B*	14HUG32B*	14HUG32B*	14HUG32B*	14HUG32B*	14HUG32B*	14HUG32B*
30	40	75	75	—	3 1/2	50-200	B	14IUH32A*	14IUH32B*	14IUH32B*	14IUH32B*	14IUH32B*	14IUH32B*	14IUH32B*	14IUH32B*	14IUH32B*	14IUH32B*	14IUH32B*	14IUH32B*	14IUH32B*	14IUH32B*
40	50	100	100	4	—	50-200	B	14JUH32A*	14JUH32B*	14JUH32B*	14JUH32B*	14JUH32B*	14JUH32B*	14JUH32B*	14JUH32B*	14JUH32B*	14JUH32B*	14JUH32B*	14JUH32B*	14JUH32B*	14JUH32B*
75	100	200	200	5	—	55-250	—	14LPU32A*	14LPU32B*	14LPU32B*	14LPU32B*	14LPU32B*	14LPU32B*	14LPU32B*	14LPU32B*	14LPU32B*	14LPU32B*	14LPU32B*	14LPU32B*	14LPU32B*	14LPU32B*
150	200	400	400	6	—	160-630	—	14MPX32A*	14MPX32B*	14MPX32B*	14MPX32B*	14MPX32B*	14MPX32B*	14MPX32B*	14MPX32B*	14MPX32B*	14MPX32B*	14MPX32B*	14MPX32B*	14MPX32B*	14MPX32B*
—	300	600	600	7* [Ⓛ]	—	400-1220	A1+CT	14NUN32A*	14NUN32B*	14NUN32B*	14NUN32B*	14NUN32B*	14NUN32B*	14NUN32B*	14NUN32B*	14NUN32B*	14NUN32B*	14NUN32B*	14NUN32B*	14NUN32B*	14NUN32B*
—	450	900	900	8 [Ⓛ]	—	400-1220	A1+CT	14PUN32A*	14PUN32B*	14PUN32B*	14PUN32B*	14PUN32B*	14PUN32B*	14PUN32B*	14PUN32B*	14PUN32B*	14PUN32B*	14PUN32B*	14PUN32B*	14PUN32B*	14PUN32B*

Open Type & Standard Width Enclosure, Single Phase, 2-Pole[Ⓛ]

Max Hp				Overload		Enclosure									
115 Volts	208/230 Volts	NEMA Size	Amp Range	Frame Size	Open Type Standard Auxiliary Contacts [Ⓛ]	NEMA 1 General Purpose		NEMA 4/4X Stainless [Ⓛ] Watertight, Dust-tight, Corrosion Resistant Ⓛ = W for 304 Stainless Steel Ⓛ = X for 316 Stainless Steel		NEMA 4X Fiberglass Watertight, Dust-tight Corrosion Resistant		NEMA 7 & 9 NEMA 3 & 4 Div. 1 and Div. 2 Class I Groups C & D Class II Groups E, F & G Class III Bolted Enclosures Indoor/Outdoor Use		NEMA 12 NEMA 3/3R [Ⓛ] Industrial Use Weatherproof (Field Convertible to 3/3R)	
Catalog Number	List Price \$	Catalog Number	List Price \$	Catalog Number	List Price \$	Catalog Number	List Price \$	Catalog Number	List Price \$	Catalog Number	List Price \$	Catalog Number	List Price \$	Catalog Number	List Price \$
1/2	1/2	0	0.75-3.4	A	14CUB12A*	14CUB12B*	14CUB12B*	14CUB12B*	14CUB12B*	14CUB12B*	14CUB12B*	14CUB12B*	14CUB12B*	14CUB12B*	14CUB12B*
1/2	3/4	0	3-12	A1	14CUC12A*	14CUC12B*	14CUC12B*	14CUC12B*	14CUC12B*	14CUC12B*	14CUC12B*	14CUC12B*	14CUC12B*	14CUC12B*	14CUC12B*
1	2	0	5.5-22	A1	14CUD12A*	14CUD12B*	14CUD12B*	14CUD12B*	14CUD12B*	14CUD12B*	14CUD12B*	14CUD12B*	14CUD12B*	14CUD12B*	14CUD12B*
1/2	3/4	1	0.75-3.4	A	14DUB12A*	14DUB12B*	14DUB12B*	14DUB12B*	14DUB12B*	14DUB12B*	14DUB12B*	14DUB12B*	14DUB12B*	14DUB12B*	14DUB12B*
1/2	3/4	1	3-12	A1	14DUC12A*	14DUC12B*	14DUC12B*	14DUC12B*	14DUC12B*	14DUC12B*	14DUC12B*	14DUC12B*	14DUC12B*	14DUC12B*	14DUC12B*
1	2	1	5.5-22	A1	14DUD12A*	14DUD12B*	14DUD12B*	14DUD12B*	14DUD12B*	14DUD12B*	14DUD12B*	14DUD12B*	14DUD12B*	14DUD12B*	14DUD12B*
3	7 1/2	2	25-100	B	14FUG12A*	14FUG12B*	14FUG12B*	14FUG12B*	14FUG12B*	14FUG12B*	14FUG12B*	14FUG12B*	14FUG12B*	14FUG12B*	14FUG12B*
7 1/2	15	3	25-100	B	14HUG12A*	14HUG12B*	14HUG12B*	14HUG12B*	14HUG12B*	14HUG12B*	14HUG12B*	14HUG12B*	14HUG12B*	14HUG12B*	14HUG12B*

Note: All starter sizes carry one maximum Hp rating (per the National Electric Code).

Ⓛ Dual voltage coils not available in size 5-8 starters.

Ⓛ For conduit hubs and conversion instructions, see page 9/110.

Ⓛ Coils D, F, or G will be wired for incoming voltage. J coil will be wired for separate source. Coils E, H, and L do not apply to single phase starters.

Ⓛ Enclosure is NEMA Type 4 (painted steel).

Ⓛ F coil 100-250V AC 50/60Hz, or DC, H coil 150-500V AC 50/60Hz, or DC

Ⓛ Only available F coil 100-250V AC 50/60Hz, or DC

Solid State Overload with Auto/Manual Reset, Class 14

Selection

 <p>NEMA 1</p>	<p>Ordering Information</p> <p>Replace the (*) with a letter from the coil table. Dual voltage coils are wired on high voltage unless specified on order.</p> <p>Field Modification Kits see page 9/104.</p> <p>Factory Modifications see page 9/119.</p> <p>Dimensions see page 9/157.</p> <p>Wiring Diagrams see page 9/173.</p> <p>Replacement Parts see page 9/131.</p>	<p>Coil Table</p> <table border="1"> <thead> <tr> <th>60Hz Voltage</th> <th>Letter</th> </tr> </thead> <tbody> <tr><td>24</td><td>J</td></tr> <tr><td>120</td><td>F</td></tr> <tr><td>110–120/220–240</td><td>A</td></tr> <tr><td>200–208</td><td>D</td></tr> <tr><td>220–240</td><td>G</td></tr> <tr><td>277</td><td>L</td></tr> <tr><td>220–240/440–480</td><td>C</td></tr> <tr><td>440–480</td><td>H</td></tr> <tr><td>575–600</td><td>E</td></tr> </tbody> </table> <p>For other voltages and frequencies, see Factory Modifications page 9/119.</p>	60Hz Voltage	Letter	24	J	120	F	110–120/220–240	A	200–208	D	220–240	G	277	L	220–240/440–480	C	440–480	H	575–600	E
	60Hz Voltage	Letter																				
24	J																					
120	F																					
110–120/220–240	A																					
200–208	D																					
220–240	G																					
277	L																					
220–240/440–480	C																					
440–480	H																					
575–600	E																					

Extra Wide Enclosure, 3-Phase, 3-Pole

Max Hp				NEMA Size	Half Size	Overload		Enclosure									
200 Volts	230 Volts	460 Volts	575 Volts			Amp Range	Frame Size	NEMA 1 General Purpose	NEMA 4/4X Stainless ^① Watertight, Dust-tight, Corrosion Resistant @ = W for 304 Stainless Steel @ = X for 316 Stainless Steel	NEMA 7 & 9 NEMA 3 & 4 Div. 1 and Div. 2 Class I Groups C & D Class II Groups E, F & G Class III Bolted Enclosures Indoor/Outdoor Use	NEMA 12 NEMA 3/3R ^① Industrial Use Weatherproof (Field Convertible to 3/3R)	Catalog Number	List Price \$	Catalog Number	List Price \$	Catalog Number	List Price \$
¼	¼	¼	½	00	—	0.25–1	A	14BUA82B*	Use Size 0	—	Use Size 0	—	Use Size 0	—	Use Size 0	—	
¼	¾	1½	2	00	—	0.75–3.4	A	14BUB82B*	Use Size 0	—	Use Size 0	—	Use Size 0	—	Use Size 0	—	
1½	1½	2	—	00	—	3–12	A1	14BUC82B*	Use Size 0	—	Use Size 0	—	Use Size 0	—	Use Size 0	—	
¼	¾	1½	2	0	—	0.25–1	A	14CUA82B*	14CUA82@*	—	14CUA82H*	—	14CUA820*	—			
¼	¾	1½	2	0	—	0.75–3.4	A	14CUB82B*	14CUB82@*	—	14CUB82H*	—	14CUB820*	—			
2	2	5	5	0	—	3–12	A1	14CUC82B*	14CUC82@*	—	14CUC82H*	—	14CUC820*	—			
3	3	—	—	0	—	5.5–22	A1	14CUD82B*	14CUD82@*	—	14CUD82H*	—	14CUD820*	—			
¼	¾	1½	2	1	—	0.25–1	A	14DUA82B*	14DUA82@*	—	14DUA82H*	—	14DUA820*	—			
¼	¾	1½	2	1	—	0.75–3.4	A	14DUB82B*	14DUB82@*	—	14DUB82H*	—	14DUB820*	—			
2	2	5	5	1	—	3–12	A1	14DUC82B*	14DUC82@*	—	14DUC82H*	—	14DUC820*	—			
3	3	10	10	1	—	5.5–22	A1	14DUD82B*	14DUD82@*	—	14DUD82H*	—	14DUD820*	—			
7½	7½	—	—	1	—	10–40	A1	14DUE82B*	14DUE82@*	—	14DUE82H*	—	14DUE820*	—			
10	10	15	15	—	1½	10–40	A1	14EUE82B*	14EUE82@*	—	14EUE82H*	—	14EUE820*	—			
10	15	25	25	2	—	13–52	B	14FUF82B*	14FUF82@*	—	14FUF82H*	—	14FUF820*	—			
15	20	30	30	—	2½	25–100	B	14GUG82B*	14GUG82@*	—	14GUG82H*	—	14GUG820*	—			
25	30	50	50	3	—	25–100	B	14HUG82B*	14HUG82@*	—	14HUG82H*	—	14HUG820*	—			
30	40	75	75	—	3¾	50–200	B	14IUH82B*	14IUH82@*	—	14IUH82H*	—	14IUH820*	—			

Note: All starter sizes carry one maximum Hp rating (per the National Electric Code).

① For conduit hubs and conversion instructions, see page 9/110.

Ambient Compensated Bimetal Overload with Manual and Auto Reset, Class 14

Selection

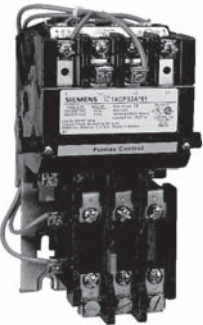
	Ordering Information	Coil Table																			
	<p>Replace the (*) with a letter from the coil table. Dual voltage coils are wired on high voltage unless specified on order.</p> <p>Heater elements see page 9/124. Single phase starters require 1 heater element. 3-phase starters require 3 heater elements.</p> <p>Field Modification Kits page 9/104.</p> <p>Factory Modifications page 9/119.</p> <p>Dimensions see page 9/140 open and 9/157 enclosed.</p> <p>Wiring Diagrams see page 9/173.</p> <p>Replacement Parts see page 9/131.</p> <p>For NO/NC SPDT contact on overload relay, replace "81" with "91". "81" indicates one NC contact.</p>	<table border="1"> <thead> <tr> <th>60Hz Voltage</th> <th>Letter</th> </tr> </thead> <tbody> <tr><td>24</td><td>J</td></tr> <tr><td>120</td><td>F</td></tr> <tr><td>110–120/220–240</td><td>A</td></tr> <tr><td>200–208</td><td>D</td></tr> <tr><td>220–240</td><td>G</td></tr> <tr><td>277</td><td>L</td></tr> <tr><td>220–240/440–480</td><td>C</td></tr> <tr><td>440–480</td><td>H</td></tr> <tr><td>575–600</td><td>E</td></tr> </tbody> </table> <p>For other voltages and frequencies, see Factory Modifications page 9/119.</p>	60Hz Voltage	Letter	24	J	120	F	110–120/220–240	A	200–208	D	220–240	G	277	L	220–240/440–480	C	440–480	H	575–600
60Hz Voltage	Letter																				
24	J																				
120	F																				
110–120/220–240	A																				
200–208	D																				
220–240	G																				
277	L																				
220–240/440–480	C																				
440–480	H																				
575–600	E																				

Open Type & Standard Width Enclosure, 3-Phase, 3-Pole

Max Hp				Contactor Amp Rating	NEMA Size	Half Size	Enclosure											
200 Volts	230 Volts	460 Volts	575 Volts				Open Type Standard Auxiliary Contacts ^④		NEMA 1 General Purpose		NEMA 4/4X Stainless ^② Watertight, Dust-tight Corrosion Resistant @ = W for 304 Stainless Steel @ = X for 316 Stainless Steel		NEMA 4X Fiberglass Watertight, Dust-tight Corrosion Resistant		NEMA 7 & 9 NEMA 3 & 4 Class I Groups C & D Class II Groups E, F & G Class III Bolted Enclosures Indoor/Outdoor Use		NEMA 12 NEMA 3/3R ^③ Industrial Use Weatherproof	
							Catalog No	\$	Catalog No	\$	Catalog No	\$	Catalog No	\$	Catalog No	\$	Catalog No	\$
1½	1½	2	2	9	00	—	14BP32A*81	14BP32B*81	Use Size 0	—	Use Size 0	—	Use Size 0	—	Use Size 0	—		
3	3	5	5	18	0	—	14CP32A*81	14CP32B*81	14CP32@*81	—	14CP32F*81	—	14CP32H*81	—	14CP32R*81	—		
7½	7½	10	10	27	1	—	14DP32A*81	14DP32B*81	14DP32@*81	—	14DP32F*81	—	14DP32H*81	—	14DP32R*81	—		
10	10	15	15	40	—	1¾	14EP32A*81	14EP32B*81	14EP32@*81	—	14EP32F*81	—	14EP32H*81	—	14EP32R*81	—		
10	15	25	25	45	2	—	14FP32A*81	14FP32B*81	14FP32@*81	—	14FP32F*81	—	14FP32H*81	—	14FP32R*81	—		
15	20	30	30	60	—	2½	14GP32A*81	14GP32B*81	14GP32@*81	—	14GP32F*81	—	14GP32H*81	—	14GP32R*81	—		
25	30	50	50	90	3	—	14HP32A*81	14HP32B*81	14HP32@*81	—	14HP32F*81	—	14HP32H*81	—	14HP32R*81	—		
30	40	75	75	115	—	3½	14IP32A*81	14IP32B*81	14IP32@*81	—	14IP32F*81	—	14IP32H*81	—	14IP32R*81	—		
40	50	100	100	135	4	—	14JG32A*81	14JG32B*81	14JG32@*81	—	14JG32F*81	—	14JG32H*81	—	14JG32R*81	—		

Open Type & Standard Width Enclosure, Single Phase, 2-Pole^③

Max Hp		Contactor Amp Rating	NEMA Size	Half Size	Enclosure											
115 Volts	208/230 Volts				Open Type		NEMA 1 General Purpose		NEMA 4/4X Stainless ^② Watertight, Dust-tight Corrosion Resistant @ = W for 304 Stainless Steel @ = X for 316 Stainless Steel		NEMA 4X Fiberglass Watertight, Dust-tight Corrosion Resistant Class II Groups E, F & G Class III		NEMA 7 & 9 NEMA 3 & 4 Div 1 and Div 2 Class I Groups C & D Bolted Enclosures		NEMA 12 NEMA 3/3R ^③ Industrial Use Weatherproof	
					Catalog No	\$	Catalog No	\$	Catalog No	\$	Catalog No	\$	Catalog No	\$	Catalog No	\$
½	1	9	00	—	14BP12A*81	14BP12B*81	Use Size 0	—	Use Size 0	—	Use Size 0	—	Use Size 0	—		
1	2	18	0	—	14CP12A*81	14CP12B*81	14CP12@*81	—	14CP12F*81	—	14CP12H*81	—	14CP12R*81	—		
2	3	27	1	—	14DP12A*81	14DP12B*81	14DP12@*81	—	14DP12F*81	—	14DP12H*81	—	14DP12R*81	—		
3	5	35	1P	—	14EP12A*81	14EP12B*81	14EP12@*81	—	14EP12F*81	—	14EP12H*81	—	14EP12R*81	—		
3	7½	45	2	—	14FP12A*81	14FP12B*81	14FP12@*81	—	14FP12F*81	—	14FP12H*81	—	14FP12R*81	—		
5	10	60	—	2½	14GP12A*81	14GP12B*81	14GP12@*81	—	14GP12F*81	—	14GP12H*81	—	14GP12R*81	—		

Extra Wide Enclosure, 3-Phase, 3-Pole^③

Max Hp				Contactor Amp Rating	NEMA Size	Half Size	Enclosure							
200 Volts	230 Volts	460 Volts	575 Volts				NEMA 1 General Purpose		NEMA 4/4X Stainless ^② Watertight, Dust-tight Corrosion Resistant @ = W for 304 Stainless Steel @ = X for 316 Stainless Steel		NEMA 7 & 9. NEMA 3 & 4 Div 1 and Div 2 Class II Groups E, F & G Bolted Enclosures		NEMA 12. NEMA 3/3R ^③ Industrial Use Weatherproof Class III	
							Catalog No	Price \$	Catalog No	Price \$	Catalog No	Price \$	Catalog No	Price \$
1½	1½	2	2	9	00	—	14BP82B*81	Use Size 0	—	Use Size 0	—	Use Size 0	—	
3	3	5	5	18	0	—	14CP82B*81	14CP82@*81	—	14CP82H*81	—	14CP82R*81	—	
7½	7½	10	10	27	1	—	14DP82B*81	14DP82@*81	—	14DP82H*81	—	14DP82R*81	—	
10	10	15	15	40	—	1¾	14EP82B*81	14EP82@*81	—	14EP82H*81	—	14EP82R*81	—	
10	15	25	25	45	2	—	14FP82B*81	14FP82@*81	—	14FP82H*81	—	14FP82R*81	—	
15	20	30	30	60	—	2½	14GP82B*81	14GP82@*81	—	14GP82H*81	—	14GP82R*81	—	
25	30	50	50	90	3	—	14HP82B*81	14HP82@*81	—	14HP82H*81	—	14HP82R*81	—	
30	40	75	75	115	—	3½	14IP82B*81	14IP82@*81	—	14IP82H*81	—	14IP82R*81	—	

Note: Hp's shown above are based on the overload amp range for the FLA's (per the National Electric Code) of typical industrial motors. All Starter Sizes carry one maximum Hp rating. For higher Hp single phase motors, use 3-phase starters, wire and set per diagram on page 9/173.

- ① To receive a single phase starter in an extra wide enclosure, order the enclosure kit from pg 16-91 and the open style starter from pg 16-14 or 16-16 as separate items.
- ② For conduit hubs and conversion instructions, see page 9/110.

- ③ Coils D, F, or G will be wired for incoming voltage. J coil will be wired for separate source. Coils E, H, and L do not apply to single phase starters.
- ④ Standard Auxiliary Contacts, Same as Contactors, refer to page 9/60.

Features and Benefits

General

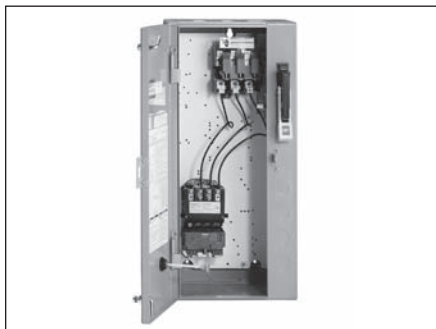

Combination Starter Features

Combination starters include the following features:

- Manufactured with Cold Forming "TOX" Process
- Solid State Overloads Standard on Sizes 5-8
- Easy to Install
- Wide Range of Enclosure Types Available
- Heavy Duty Quarter Turns
- 100kA Short Circuit Current Rating when Protected with Class R Fuses to 600V or MCP to 480V
- Visible Blade Disconnect
- Industrial Type Disconnect Handle
- UL listed file #E185287 (class 17, 18, 25, 26 & 32)
- CSA certified file #LR 6535 (class 17, 18, 25, 26 & 32)

Application

A combination starter meets National Electrical Code requirements for:

1. A means of providing short circuit motor protection with fused or breaker disconnection of line voltage.
2. A means of safeguarding personnel from contact with live parts and from accidental starting of machinery by disconnecting the motor and the controller.
3. A motor controller with overload protection.

Prewired combination starters eliminate the cost of wiring between separate disconnect and starter. Factory testing assures field performance. Combination starters also provide a more compact and attractive installation than separate units.

Enclosure Types

Combination starters are available in NEMA 1, 12/3/3R/4 (painted), 4/4X

(stainless), 4X fiberglass and 7 & 9 enclosures. Enclosures protect personnel from contact with live parts and depending upon the construction, protect the control in varying degrees from physical damage and harmful atmospheres. All enclosures are supplied with corrosion resistant finishes.

Heavy Duty Disconnect Switches

The disconnect switch that goes the distance in durability, performance and reliability has the following advantages:

- Visible blades for the highest level of safety
- Double break switching action to reduce arcing, increase lifetime and eliminate the "electric hinge"
- More rugged positive action switch
- Oversized lugs are standard
- Line side shield to help guard personnel from contact with live parts
- Higher horsepower rating for design E high efficiency motors
- UL listed for IlSCO, Burndy and T&B crimp type lugs
- The 200A switch accepts up to 300 MCM versus 250 MCM wire size

Its rugged construction - with a high fault withstand rating of 100kA at 600 VAC when fused with class R rated fuses - meets the most stringent industry standards set forth by the automotive, petro-chemical, and pulp and paper industries. UL recognized and CSA certified, our disconnect switches are available either non-fusible or fusible with class R and class J fuse clips.



Enclosure Kits for NEMA Combination Starters Description

You can assemble a non-stocked combination starter per your unanticipated needs in minutes. Say, for example, your customer needs a fusible combination starter that you don't have in stock. You need in now, but don't sweat it.

Simply start with the enclosure kit which has the handle preinstalled. You install the required starter and fusible disconnect, connect the power wire and you are finished. Within minutes, you have the required combination starter in your hands. No more waiting on the factory. You need it, you got it!

What Is In It For You!

- **Reduce Lead-time** - What used to take days to get now takes minutes
- **Reduced Inventory** - Instead of stocking scores of various combination starters, simply stock a few enclosure kits, disconnect kits, circuit breaker kits and open starters. With these basic "building blocks" you virtually have hundreds of products on-hand
- **Quality** - The same high level of quality you have been accustomed to with our products will also be found in these new enclosure kits
- **UL Listed** - By correctly following the instructions included with the kits, the product you build is UL/CSA Listed

Refer to page 9/115 for more details.

Siemens Type ETI Circuit Breaker

The ETI circuit breaker is a device designed specifically for application in motor circuits. The ETI is a magnetic only protective device designed to provide protection against short circuit current.

The instantaneous-only type ETI circuit breaker employs adjustable magnetic trip settings to allow broader application ranges and a higher degree of motor short circuit protection.



Heavy Duty Starters

These combination starters use the same starters described in the heavy duty starter section of this catalog.

Non-Fusible with Solid State Overload, Class 17

Selection

	Ordering Information	Coil Table																			
	<p>Replace the (*) with a letter from the coil table. Dual voltage coils are wired on high voltage unless specified on order.</p> <p>For Fusible Styles see page 9/20.</p> <p>Field Modification Kits see page 9/104.</p> <p>Factory Modifications see page 9/119.</p> <p>Dimensions see page 9/159.</p> <p>Wiring Diagrams see page 9/174.</p> <p>Replacement Parts see page 9/131.</p>	<table border="1"> <thead> <tr> <th>60Hz Voltage</th> <th>Letter</th> </tr> </thead> <tbody> <tr><td>24</td><td>J</td></tr> <tr><td>120</td><td>F</td></tr> <tr><td>110–120/220–240[Ⓣ]</td><td>A</td></tr> <tr><td>200–208</td><td>D</td></tr> <tr><td>220–240</td><td>G</td></tr> <tr><td>277</td><td>L</td></tr> <tr><td>220–240/440–480[Ⓣ]</td><td>C</td></tr> <tr><td>440–480</td><td>H</td></tr> <tr><td>575–600</td><td>E</td></tr> </tbody> </table> <p>For other voltages and frequencies, see Factory Modifications page 9/119.</p>	60Hz Voltage	Letter	24	J	120	F	110–120/220–240 [Ⓣ]	A	200–208	D	220–240	G	277	L	220–240/440–480 [Ⓣ]	C	440–480	H	575–600
60Hz Voltage	Letter																				
24	J																				
120	F																				
110–120/220–240 [Ⓣ]	A																				
200–208	D																				
220–240	G																				
277	L																				
220–240/440–480 [Ⓣ]	C																				
440–480	H																				
575–600	E																				

Standard Width Enclosure, 3 Phase, 3-Pole

Max Hp				NEMA Size	Half Size	Overload		Disc. Amp Range	Enclosure							
200 Volts	230 Volts	460 Volts	575 Volts			Amp Range	Frame Size		NEMA 1 General Purpose	NEMA 4/4X Stainless [Ⓣ] Watertight, Dust-tight, Corrosion Resistant Ⓣ = W for 304 Stainless Steel Ⓣ = X for 316 Stainless Steel	NEMA 4X Fiberglass Watertight, Dust-tight Corrosion Resistant	NEMA 12, NEMA 3/3R [Ⓣ] , NEMA 4 Painted (thru size 4) Industrial Use Weatherproof Watertight, Dust-tight				
									Catalog Number	List Price \$	Catalog Number	List Price \$	Catalog Number	List Price \$	Catalog Number	List Price \$
1/8	1/8	1/8	1/8	0	—	0.25–1	A	30	17CUA92B*		17CUA92@*		17CUA92F*		17CUA92N*	
1/4	3/8	1 1/2	2	0	—	0.75–3.4	A	30	17CUB92B*		17CUB92@*		17CUB92F*		17CUB92N*	
2	2	5	5	0	—	3–12	A1	30	17CUC92B*		17CUC92@*		17CUC92F*		17CUC92N*	
3	3	—	—	0	—	5.5–22	A1	30	17CUD92B*		17CUD92@*		17CUD92F*		17CUD92N*	
1/2	1/2	1 1/2	2	1	—	0.25–1	A	30	17DUA92B*		17DUA92@*		17DUA92F*		17DUA92N*	
1/2	3/4	1 1/2	2	1	—	0.75–3.4	A	30	17DUB92B*		17DUB92@*		17DUB92F*		17DUB92N*	
2	2	5	5	1	—	3–12	A1	30	17DUC92B*		17DUC92@*		17DUC92F*		17DUC92N*	
3	3	10	10	1	—	5.5–22	A1	30	17DUD92B*		17DUD92@*		17DUD92F*		17DUD92N*	
7 1/2	7 1/2	—	—	1	—	10–40	A1	60	17DUE92B*		17DUE92@*		17DUE92F*		17DUE92N*	
10	10	15	15	—	1 1/2	10–40	A1	60	17EUE92B*		17EUE92@*		17EUE92F*		17EUE92N*	
10	15	25	25	2	—	13–52	B	60	17FUF92B*		17FUF92@*		17FUF92F*		17FUF92N*	
15	20	30	30	—	2 1/2	25–100	B	100 [Ⓣ]	17GUG92B*		17GUG92@*		17GUG92F*		17GUG92N*	
20 [Ⓣ]	25 [Ⓣ]	50	50	3	—	25–100	B	100	17HUG92B*		17HUG92@*		17HUG92F*		17HUG92N*	
30	40	75	75	—	3 1/2	50–200	B	200	17IUH92B*		17IUH92@*		17IUH92F*		17IUH92N*	
40	50	100	100	4	—	50–200	B	200	17JUH92B*		17JUH92@*		17JUH92F*		17JUH92N*	
75	100	200	200	5	—	55–250	—	400 [Ⓣ]	17LPU92B*		17LPU92E* [Ⓣ]		—	—	17LPU92N*	
150	200	400	400	6	—	160–630	—	600	17MPX92B*		17MPX92E* [Ⓣ]		—	—	17MPX92N*	
—	300	600	600	7 [Ⓣ]	—	400–1220	A1+CT	1200	17NUN92B*		—	—	—	—	17NUN92N*	
—	450	900	900	8 [Ⓣ]	—	400–1220	A1+CT	1600	17PUN92B*		—	—	—	—	17PUN92N*	

Note: All starter sizes carry one maximum Hp rating (per the National Electric Code).

- ① Dual voltage coils not available in starter sizes 5–8.
- ② For conduit hubs and conversion instructions, see page 9/110.
- ③ For 60A disconnect, order fusible cat. no. page 9/20.

- Ⓣ For 25 HP and 200A disconnect, order fusible cat. no. page 9/20.
- Ⓣ For 30HP and 200A disconnect, order fusible cat. no. page 9/20.
- Ⓣ For 600A disconnect, order fusible cat. no. page 9/20.
- Ⓣ Enclosure is NEMA Type 4 (painted steel).
- Ⓣ F coil 100-250V AC 50/60Hz, or DC,

- H coil 150-500V AC 50/60Hz, or DC
- Ⓣ Only available
- F coil 100-250V AC 50/60Hz, or DC

Non-Fusible with Solid State Overload, Class 17

Selection

	Ordering Information	Coil Table																			
	<p>Replace the (*) with a letter from the coil table. Dual voltage coils are wired on high voltage unless specified on order.</p> <p>For Fusible Styles see page 9/21.</p> <p>Field Modification Kits see page 9/104.</p> <p>Factory Modifications see page 9/119.</p> <p>Dimensions see page 9/159.</p> <p>Wiring Diagrams see page 9/174.</p> <p>Replacement Parts see page 9/131.</p>	<table border="1"> <thead> <tr> <th>60Hz Voltage</th> <th>Letter</th> </tr> </thead> <tbody> <tr><td>24</td><td>J</td></tr> <tr><td>120</td><td>F</td></tr> <tr><td>110-120/220-240[ⓐ]</td><td>A</td></tr> <tr><td>200-208</td><td>D</td></tr> <tr><td>220-240</td><td>G</td></tr> <tr><td>277</td><td>L</td></tr> <tr><td>220-240/440-480[ⓑ]</td><td>C</td></tr> <tr><td>440-480</td><td>H</td></tr> <tr><td>575-600</td><td>E</td></tr> </tbody> </table> <p>For other voltages and frequencies, see Factory Modifications page 9/119.</p>	60Hz Voltage	Letter	24	J	120	F	110-120/220-240 [ⓐ]	A	200-208	D	220-240	G	277	L	220-240/440-480 [ⓑ]	C	440-480	H	575-600
60Hz Voltage	Letter																				
24	J																				
120	F																				
110-120/220-240 [ⓐ]	A																				
200-208	D																				
220-240	G																				
277	L																				
220-240/440-480 [ⓑ]	C																				
440-480	H																				
575-600	E																				

Extra Wide Enclosure, 3-Phase, 3-Pole

Hp				NEMA Size	Half Size	Overload		Disc. Amp Range	Enclosure					
200 Volts	230 Volts	460 Volts	575 Volts			Amp Range	Frame Size		NEMA 1 General Purpose		NEMA 4/4X Stainless [ⓐ] Watertight, Dust-tight, Corrosion Resistant ⓐ = W for 304 Stainless Steel ⓐ = X for 316 Stainless Steel		NEMA 12, NEMA 3/3R [ⓑ] , NEMA 4 Painted Industrial Use Weatherproof Watertight, Dust-tight	
									Catalog Number	List Price \$	Catalog Number	List Price \$	Catalog Number	List Price \$
1/8	1/8	1/8	1/8	0	—	0.25-1	A	30	17CUA82B*		17CUA82@*		17CUA82N*	
1/8	1/8	1 1/2	2	0	—	0.75-3.4	A	30	17CUB82B*		17CUB82@*		17CUB82N*	
2	2	5	5	0	—	3-12	A1	30	17CUC82B*		17CUC82@*		17CUC82N*	
3	3	—	—	0	—	5.5-22	A1	30	17CUD82B*		17CUD82@*		17CUD82N*	
1/8	1/8	1/8	1/8	1	—	0.25-1	A	30	17DUA82B*		17DUA82@*		17DUA82N*	
1/8	1/8	1 1/2	2	1	—	0.75-3.4	A	30	17DUB82B*		17DUB82@*		17DUB82N*	
2	2	5	5	1	—	3-12	A1	30	17DUC82B*		17DUC82@*		17DUC82N*	
3	3	10	10	1	—	5.5-22	A1	30	17DUD82B*		17DUD82@*		17DUD82N*	
7 1/2	7 1/2	—	—	1	—	10-40	A1	60	17DUE82B*		17DUE82@*		17DUE82N*	
10	10	15	15	—	1 1/2	10-40	A1	60	17EUE82B*		17EUE82@*		17EUE82N*	
10	15	25	25	2	—	13-52	B	60	17FUF82B*		17FUF82@*		17FUF82N*	
15	20	30	30	—	2 1/2	25-100	B	100 [ⓐ]	17GUG82B*		17GUG82@*		17GUG82N*	
20 [ⓐ]	25 [ⓐ]	50	50	3	—	25-100	B	100	17HUG82B*		17HUG82@*		17HUG82N*	

Note: All starter sizes carry one maximum Hp rating (per the National Electric Code).

[ⓐ] For conduit hubs and conversion instructions, see page 9/110.

[ⓑ] For 60A disconnect, order fusible cat. no. page 9/21.

[ⓒ] For 25 HP and 200A disconnect, order fusible cat. no. page 9/21.

[ⓓ] For 30HP and 200A disconnect, order fusible cat. no. page 9/21.

Non-Fusible with Ambient Compensated Bimetal Overload, Class 17

Selection

	Ordering Information	Coil Table																			
	<p>Replace the (*) with a letter from the coil table. Dual voltage coils are wired on high voltage unless specified on order.</p> <p>Heater elements see page 9/124. (3 required)</p> <p>Field Modification Kits see page 9/104.</p> <p>Factory Modifications see page 9/119.</p> <p>Dimensions see page 9/159.</p> <p>Wiring Diagrams see page 9/174.</p> <p>Replacement Parts see page 9/131.</p> <p>For NO/NC SPDT contact on overload relay, replace "81" with "91". "81" indicates one NC contact.</p>	<table border="1"> <thead> <tr> <th>60Hz Voltage</th> <th>Letter</th> </tr> </thead> <tbody> <tr><td>24</td><td>J</td></tr> <tr><td>120</td><td>F</td></tr> <tr><td>110–120/220–240[Ⓛ]</td><td>A</td></tr> <tr><td>200–208</td><td>D</td></tr> <tr><td>220–240</td><td>G</td></tr> <tr><td>277</td><td>L</td></tr> <tr><td>220–240/440–480[Ⓛ]</td><td>C</td></tr> <tr><td>440–480</td><td>H</td></tr> <tr><td>575–600</td><td>E</td></tr> </tbody> </table> <p>For other voltages and frequencies, see Factory Modifications page 9/119.</p>	60Hz Voltage	Letter	24	J	120	F	110–120/220–240 [Ⓛ]	A	200–208	D	220–240	G	277	L	220–240/440–480 [Ⓛ]	C	440–480	H	575–600
60Hz Voltage	Letter																				
24	J																				
120	F																				
110–120/220–240 [Ⓛ]	A																				
200–208	D																				
220–240	G																				
277	L																				
220–240/440–480 [Ⓛ]	C																				
440–480	H																				
575–600	E																				

Standard Width Enclosure, 3-Phase, 3-Pole

Max Hp				NEMA Size	Half Size	Disc Amp Rating	Enclosure							
200 Volts	230 Volts	460 Volts	575 Volts				NEMA 1 General Purpose		NEMA 4/4X Stainless [Ⓛ] Watertight, Dust-tight Corrosion Resistant Ⓛ = W for 304 Stainless Steel Ⓛ = X for 316 Stainless Steel		NEMA 4X Fiberglass Watertight, Dust-tight Corrosion Resistant Weatherproof		NEMA 12, NEMA 3/3R, [Ⓛ] NEMA 4 Painted Industrial Use Watertight, Dust-tight	
Catalog Number	List Price \$	Catalog Number	List Price \$				Catalog Number	List Price \$	Catalog Number	List Price \$	Catalog Number	List Price \$	Catalog Number	List Price \$
3	3	5	5	0	—	30	17CP92B*81		17CP92@*81		17CP92F*81		17CP92N*81	
7½ [Ⓛ]	7½ [Ⓛ]	10	10	1	—	30	17DP92B*81		17DP92@*81		17DP92F*81		17DP92N*81	
10	10	15	15	—	1¼	60	17EP92B*81		17EP92@*81		17EP92F*81		17EP92N*81	
10	15	25	25	2	—	60	17FP92B*81		17FP92@*81		17FP92F*81		17FP92N*81	
15	20	30	30	—	2½	100	17GP92B*81		17GP92@*81		17GP92F*81		17GP92N*81	
25 [Ⓛ]	30 [Ⓛ]	50	50	3	—	100	17HP92B*81		17HP92@*81		17HP92F*81		17HP92N*81	
30	40	75	75	—	3½	200	17IP92B*81		17IP92@*81		17IP92F*81		17IP92N*81	
40	50	100	100	4	—	200	17JP92B*81		17JP92@*81		17JP92F*81		17JP92N*81	

Extra Wide Enclosure, 3-Phase, 3-Pole

Max Hp				NEMA Size	Half Size	Disc Amp Rating	Enclosure					
200 Volts	230 Volts	460 Volts	575 Volts				NEMA 1 General Purpose		NEMA 4/4X Stainless [Ⓛ] Watertight, Dust-tight Corrosion Resistant Ⓛ = W for 304 Stainless Steel Ⓛ = X for 316 Stainless Steel		NEMA 12, NEMA 3/3R, [Ⓛ] NEMA 4 Painted Industrial Use Weatherproof Watertight, Dust-tight	
Catalog Number	List Price \$	Catalog Number	List Price \$				Catalog Number	List Price \$	Catalog Number	List Price \$	Catalog Number	List Price \$
3	3	5	5	0	—	30	17CP82B*81		17CP82@*81		17CP82N*81	
7½ [Ⓛ]	7½ [Ⓛ]	10	10	1	—	30	17DP82B*81		17DP82@*81		17DP82N*81	
10	10	15	15	—	1¼	60	17EP82B*81		17EP82@*81		17EP82N*81	
10	15	25	25	2	—	60	17FP82B*81		17FP82@*81		17FP82N*81	
15	20	30	30	—	2½	100	17GP82B*81		17GP82@*81		17GP82N*81	
25 [Ⓛ]	30 [Ⓛ]	50	50	3	—	100	17HP82B*81		17HP82@*81		17HP82N*81	

Standard Width Enclosure, Single Phase, (Catalog Numbers are three phase, wire for single phase in the field)

Max Hp		NEMA Size	Half Size	Disc Amp Rating	Enclosure							
115 Volts	208/230 Volts				NEMA 1 General Purpose		NEMA 4/4X Stainless [Ⓛ] Watertight, Dust-tight Corrosion Resistant Ⓛ = W for 304 Stainless Steel Ⓛ = X for 316 Stainless Steel		NEMA 4X Fiberglass Watertight, Dust-tight Corrosion Resistant		NEMA 12, NEMA 3/3R, [Ⓛ] NEMA 4 Painted Industrial Use Weatherproof Watertight, Dust-tight	
Catalog Number	List Price \$				Catalog Number	List Price \$	Catalog Number	List Price \$	Catalog Number	List Price \$	Catalog Number	List Price \$
1	2	0	—	30	17CP92B*81		17CP92@*81		17CP92F*81		17CP92N*81	
2	3	1	—	30	17DP92B*81		17DP92@*81		17DP92F*81		17DP92N*81	
3	5	1P	—	60	17EP92B*81		17EP92@*81		17EP92F*81		17EP92N*81	
3	7½	2	—	60	17FP92B*81		17FP92@*81		17FP92F*81		17FP92N*81	
5	10	—	2½	100	17GP92B*81		17GP92@*81		17GP92F*81		17GP92N*81	

Note: Hp's shown above are based on the overload amp range for the FLA's (per the National Electric Code) of typical industrial motors. All starter sizes carry one maximum Hp rating.

[Ⓛ] For conduit hubs and conversion instructions, see page 9/110.

[Ⓛ] For 60A disc, order fusible cat. no. page 9/22.
[Ⓛ] For 200A disc, order fusible cat. no. page 9/22.

Fusible with Solid State Overload, Class 17

Selection



Ordering Information

Replace the (*) with a letter from the coil table. Dual voltage coils are wired on high voltage unless specified on order.
 Field Modification Kits see page 9/104.
 Factory Modifications see page 9/119.
 Dimensions see page 9/159.
 Wiring Diagrams see page 9/174.
 Replacement Parts see page 9/131.

Coil Table

60Hz Voltage	Letter
24	J
120	F
110-120/220-240 [Ⓣ]	A
200-208	D
220-240	G
277	L
220-240/440-480 [Ⓣ]	C
440-480	H
575-600	E

For other voltages and frequencies, see Factory Modifications page 9/119.

Standard Width Enclosure, 3-Phase, 3-Pole[Ⓢ]

Max Hp				NEMA Size	Half Size	Overload		Disc. Amp Range	Fuse Clip Amp/Volts	Enclosure							
200 Volts	230 Volts	460 Volts	575 Volts			Amp Range	Frame Size			NEMA 1 General Purpose	NEMA 4/4X Stainless [Ⓣ] Watertight, Dust-tight, Corrosion Resistant Ⓣ = W for 304 Stainless Steel Ⓣ = X for 316 Stainless Steel	NEMA 4X Fiberglass Watertight, Dust-tight Corrosion Resistant	NEMA 12, NEMA 3/3R [Ⓣ] , NEMA 4 Painted (thru size 4) Industrial Use Weatherproof Watertight, Dust-tight				
										Catalog Number	List Price \$	Catalog Number	List Price \$	Catalog Number	List Price \$	Catalog Number	List Price \$
1/8	1/8	—	—	0	—	0.25-1	A	30	30A/250V	17CUA92B*10	—	17CUA92@*10	—	17CUA92F*10	—	17CUA92N*10	—
—	—	1/8	1/8	0	—	0.25-1	A	30	30A/600V	17CUA92B*11	—	17CUA92@*11	—	17CUA92F*11	—	17CUA92N*11	—
1/4	1/4	—	—	0	—	0.75-3.4	A	30	30A/250V	17CUB92B*10	—	17CUB92@*10	—	17CUB92F*10	—	17CUB92N*10	—
—	—	1/4	—	0	—	0.75-3.4	A	30	30A/600V	17CUB92B*11	—	17CUB92@*11	—	17CUB92F*11	—	17CUB92N*11	—
2	2	—	—	0	—	3-12	A1	30	30A/250V	17CUC92B*10	—	17CUC92@*10	—	17CUC92F*10	—	17CUC92N*10	—
—	—	5	5	0	—	3-12	A1	30	30A/600V	17CUC92B*11	—	17CUC92@*11	—	17CUC92F*11	—	17CUC92N*11	—
3	3	—	—	0	—	5.5-22	A1	30	30A/250V	17CUD92B*10	—	17CUD92@*10	—	17CUD92F*10	—	17CUD92N*10	—
1/2	1/2	—	—	1	—	0.25-1	A	30	30A/250V	17DUA92B*10	—	17DUA92@*10	—	17DUA92F*10	—	17DUA92N*10	—
—	—	1/2	1/2	1	—	0.25-1	A	30	30A/600V	17DUA92B*11	—	17DUA92@*11	—	17DUA92F*11	—	17DUA92N*11	—
1/2	3/4	—	—	1	—	0.75-3.4	A	30	30A/250V	17DUB92B*10	—	17DUB92@*10	—	17DUB92F*10	—	17DUB92N*10	—
—	—	1 1/2	—	1	—	0.75-3.4	A	30	30A/600V	17DUB92B*11	—	17DUB92@*11	—	17DUB92F*11	—	17DUB92N*11	—
2	2	—	—	1	—	3-12	A1	30	30A/250V	17DUC92B*10	—	17DUC92@*10	—	17DUC92F*10	—	17DUC92N*10	—
—	—	5	5	1	—	3-12	A1	30	30A/600V	17DUC92B*11	—	17DUC92@*11	—	17DUC92F*11	—	17DUC92N*11	—
3	3	—	—	1	—	5.5-22	A1	30	30A/250V	17DUD92B*10	—	17DUD92@*10	—	17DUD92F*10	—	17DUD92N*10	—
—	—	10	10	1	—	5.5-22	A1	30	30A/600V	17DUD92B*11	—	17DUD92@*11	—	17DUD92F*11	—	17DUD92N*11	—
7 1/2	7 1/2	—	—	1	—	10-40	A1	30	30A/250V	17DUE92B*10	—	17DUE92@*10	—	17DUE92F*10	—	17DUE92N*10	—
7 1/2	7 1/2	—	—	1	—	10-40	A1	60	60A/250V	17DUE92B*12	—	17DUE92@*12	—	17DUE92F*12	—	17DUE92N*12	—
—	—	15	15	—	1 1/2	10-40	A1	60	60A/600V	17EUE92B*13	—	17EUE92@*13	—	17EUE92F*13	—	17EUE92N*13	—
10	10	—	—	—	1 1/2	10-40	A1	60	60A/250V	17EUE92B*12	—	17EUE92@*12	—	17EUE92F*12	—	17EUE92N*12	—
10	15	—	—	2	—	13-52	B	60	60A/250V	17FUF92B*12	—	17FUF92@*12	—	17FUF92F*12	—	17FUF92N*12	—
—	—	25	25	2	—	13-52	B	60	60A/600V	17FUF92B*13	—	17FUF92@*13	—	17FUF92F*13	—	17FUF92N*13	—
—	—	—	30	—	2 1/2	25-100	B	60	60A/600V	17GUG92B*13	—	17GUG92@*13	—	17GUG92F*13	—	17GUG92N*13	—
—	—	30	—	—	2 1/2	25-100	B	100	100A/600V	17GUG92B*15	—	17GUG92@*15	—	17GUG92F*15	—	17GUG92N*15	—
15	20	—	—	—	2 1/2	25-100	B	100	100A/250V	17GUG92B*14	—	17GUG92@*14	—	17GUG92F*14	—	17GUG92N*14	—
20	25	—	—	3	—	25-100	B	100	100A/250V	17HUG92B*14	—	17HUG92@*14	—	17HUG92F*14	—	17HUG92N*14	—
—	—	50	50	3	—	25-100	B	100	100A/600V	17HUG92B*15	—	17HUG92@*15	—	17HUG92F*15	—	17HUG92N*15	—
25	30	—	—	3	—	25-100	B	200	200A/250V	17HUG92B*16	—	17HUG92@*16	—	17HUG92F*16	—	17HUG92N*16	—
30	40	—	—	—	3 1/2	50-200	B	200	200A/250V	17IUH92B*16	—	17IUH92@*16	—	17IUH92F*16	—	17IUH92N*16	—
—	—	75	75	—	3 1/2	50-200	B	200	200A/600V	17IUH92B*17	—	17IUH92@*17	—	17IUH92F*17	—	17IUH92N*17	—
40	50	—	—	4	—	50-200	B	200	200A/250V	17JUH92B*16	—	17JUH92@*16	—	17JUH92F*16	—	17JUH92N*16	—
—	—	100	100	4	—	50-200	B	200	200A/600V	17JUH92B*17	—	17JUH92@*17	—	17JUH92F*17	—	17JUH92N*17	—
75	100	—	—	5	—	55-250	—	400	400A/250V	17LPU92B*18	—	17LPU92@*18	—	—	—	17LPU92N*18	—
—	100	—	—	5	—	55-250	—	600	600A/250V [Ⓣ]	17LPU92B*20	—	17LPU92E*20 [Ⓣ]	—	—	—	17LPU92N*20	—
—	—	125	5	—	—	55-250	—	200	200A/600V	17LPU92B*17	—	17LPU92E*17 [Ⓣ]	—	—	—	17LPU92N*17	—
—	—	200	5	—	—	55-250	—	400	400A/600V	17LPU92B*19	—	17LPU92E*19 [Ⓣ]	—	—	—	17LPU92N*19	—
—	—	200	5	—	—	55-250	—	600	600A/600V [Ⓣ]	17LPU92B*21	—	17LPU92E*21 [Ⓣ]	—	—	—	17LPU92N*21	—
150	200	—	—	6	—	160-630	—	600	600A/250V	17MPX92B*20	—	17MPX92E*20 [Ⓣ]	—	—	—	17MPX92N*20	—
—	—	400	400	6	—	160-630	—	600	600A/600V	17MPX92B*21	—	17MPX92E*21 [Ⓣ]	—	—	—	17MPX92N*21	—
—	—	400	400	6	—	160-630	—	800	800A/600V	17MPX92B*23	—	17MPX92E*23 [Ⓣ]	—	—	—	17MPX92N*23	—
—	—	600	600	7 [Ⓣ]	—	400-1220	A1+CT	1200	1200A/600V	17NUN92B*24	—	—	—	—	—	17NUN92N*24	—
—	—	900	900	8 [Ⓣ]	—	400-1220	A1+CT	1600	1600A/600V	17PUN92B*25	—	—	—	—	—	17PUN92N*25	—

Note: All starter sizes carry one maximum Hp rating (per the National Electric Code).

Ⓣ Dual voltage coils not available in starter sizes 5-8.
 Ⓣ For conduit hubs and conversion instructions, see page 9/110.

Ⓣ Use Class J fuses only.
 Ⓣ Enclosure is NEMA Type 4 (painted steel).
 Ⓣ Single phase wiring page 9/173.
 Ⓣ F coil 100-250V AC 50/60Hz, or DC,
 H coil 150-500V AC 50/60Hz, or DC

Ⓣ Only available
 F coil 100-250V AC 50/60Hz, or DC

Fusible with Solid State Overload, Class 17

Selection

	Ordering Information	Coil Table																			
	<p>Replace the (*) with a letter from the coil table. Dual voltage coils are wired on high voltage unless specified on order.</p> <p>Field Modification Kits see page 9/104.</p> <p>Factory Modifications see page 9/119.</p> <p>Dimensions see page 9/159.</p> <p>Wiring Diagrams see page 9/174.</p> <p>Replacement Parts see page 9/131.</p>	<table border="1"> <thead> <tr> <th>60Hz Voltage</th> <th>Letter</th> </tr> </thead> <tbody> <tr><td>24</td><td>J</td></tr> <tr><td>120</td><td>F</td></tr> <tr><td>110–120/220–240</td><td>A</td></tr> <tr><td>200–208</td><td>D</td></tr> <tr><td>220–240</td><td>G</td></tr> <tr><td>277</td><td>L</td></tr> <tr><td>220–240/440–480</td><td>C</td></tr> <tr><td>440–480</td><td>H</td></tr> <tr><td>575–600</td><td>E</td></tr> </tbody> </table> <p>For other voltages and frequencies, see Factory Modifications page 9/119.</p>	60Hz Voltage	Letter	24	J	120	F	110–120/220–240	A	200–208	D	220–240	G	277	L	220–240/440–480	C	440–480	H	575–600
60Hz Voltage	Letter																				
24	J																				
120	F																				
110–120/220–240	A																				
200–208	D																				
220–240	G																				
277	L																				
220–240/440–480	C																				
440–480	H																				
575–600	E																				

Extra Wide Enclosure, 3-Phase, 3-Pole

Max Hp				NEMA Size	Half Size	Overload		Disc. Amp Range	Fuse Clip Amp/Volts	Enclosure					
200 Volts	230 Volts	460 Volts	575 Volts			Amp Range	Frame Size			NEMA 1 General Purpose	NEMA 4/4X Stainless [Ⓢ] Watertight, Dust-tight, Ⓢ = W for 304 Stainless Steel Ⓢ = X for 316 Stainless Steel	NEMA 12, NEMA 3/3R [Ⓢ] , NEMA 4 Painted Industrial Use Weatherproof Watertight, Dust-tight	Catalog Number	List Price \$	Catalog Number
1/8	1/8	—	—	0	—	0.25–1	A	30	30A/250V	17CUA82B*10		17CUA82@*10		17CUA82N*10	
—	—	1/8	1/8	0	—	0.25–1	A	30	30A/600V	17CUA82B*11		17CUA82@*11		17CUA82N*11	
1/4	1/4	—	—	0	—	0.75–3.4	A	30	30A/250V	17CUB82B*10		17CUB82@*10		17CUB82N*10	
—	—	1 1/2	2	0	—	0.75–3.4	A	30	30A/600V	17CUB82B*11		17CUB82@*11		17CUB82N*11	
2	2	—	—	0	—	3–12	A1	30	30A/250V	17CUC82B*10		17CUC82@*10		17CUC82N*10	
—	—	5	5	0	—	3–12	A1	30	30A/600V	17CUC82B*11		17CUC82@*11		17CUC82N*11	
3	3	—	—	0	—	5.5–22	A1	30	30A/250V	17CUD82B*10		17CUD82@*10		17CUD82N*10	
1/2	1/2	—	—	1	—	0.25–1	A	30	30A/250V	17DUA82B*10		17DUA82@*10		17DUA82N*10	
—	—	1/8	1/8	1	—	0.25–1	A	30	30A/600V	17DUA82B*11		17DUA82@*11		17DUA82N*11	
1/2	1/2	—	—	1	—	0.75–3.4	A	30	30A/250V	17DUB82B*10		17DUB82@*10		17DUB82N*10	
—	—	1 1/2	2	1	—	0.75–3.4	A	30	30A/600V	17DUB82B*11		17DUB82@*11		17DUB82N*11	
2	2	—	—	1	—	3–12	A1	30	30A/250V	17DUC82B*10		17DUC82@*10		17DUC82N*10	
—	—	5	5	1	—	3–12	A1	30	30A/600V	17DUC82B*11		17DUC82@*11		17DUC82N*11	
3	3	—	—	1	—	5.5–22	A1	30	30A/250V	17DUD82B*10		17DUD82@*10		17DUD82N*10	
—	—	10	10	1	—	5.5–22	A1	30	30A/600V	17DUD82B*11		17DUD82@*11		17DUD82N*11	
5	5	—	—	1	—	10–40	A1	30	30A/250V	17DUE82B*10		17DUE82@*10		17DUE82N*10	
7 1/2	7 1/2	—	—	1	—	10–40	A1	60	60A/250V	17DUE82B*12		17DUE82@*12		17DUE82N*12	
—	—	15	15	—	1 1/2	10–40	A1	60	60A/600V	17EUE82B*13		17EUE82@*13		17EUE82N*13	
10	10	—	—	—	1 1/2	10–40	A1	60	60A/250V	17EUE82B*12		17EUE82@*12		17EUE82N*12	
10	15	—	—	2	—	13–52	B	60	60A/250V	17FUF82B*12		17FUF82@*12		17FUF82N*12	
—	—	25	25	2	—	13–52	B	60	60A/600V	17FUF82B*13		17FUF82@*13		17FUF82N*13	
—	—	—	30	—	2 1/2	25–100	B	60	60A/600V	17GUG82B*13		17GUG82@*13		17GUG82N*13	
—	—	30	—	—	2 1/2	25–100	B	100	100A/600V	17GUG82B*15		17GUG82@*15		17GUG82N*15	
15	20	—	—	—	2 1/2	25–100	B	100	100A/250V	17GUG82B*14		17GUG82@*14		17GUG82N*14	
20	25	—	—	3	—	25–100	B	100	100A/250V	17HUG82B*14		17HUG82@*14		17HUG82N*14	
—	—	50	50	3	—	25–100	B	100	100A/600V	17HUG82B*15		17HUG82@*15		17HUG82N*15	
25	30	—	—	3	—	25–100	B	200	200A/250V	17HUG82B*16		17HUG82@*16		17HUG82N*16	

Note: All starter sizes carry one maximum Hp rating (per the National Electric Code).

Ⓢ For conduit hubs and conversion instructions, see page 9/110.

Fusible with Ambient Compensated Bimetal Overload, Class 17

Selection

	Ordering Information	Coil Table																			
	<p>Replace the (*) with a letter from the coil table. Dual voltage coils are wired on high voltage unless specified on order.</p> <p>Heater elements see page 9/124. (3 required)</p> <p>Field Modification Kits see page 9/104.</p> <p>Factory Modifications see page 9/119.</p> <p>Dimensions see page 9/159.</p> <p>Wiring Diagrams see page 9/174.</p> <p>Replacement Parts see page 9/131.</p> <p>For NO/NC SPDT contact on overload relay, replace "81" with "91". "81" indicates one NC contact.</p>	<table border="1"> <thead> <tr> <th>60Hz Voltage</th> <th>Letter</th> </tr> </thead> <tbody> <tr><td>24</td><td>J</td></tr> <tr><td>120</td><td>F</td></tr> <tr><td>110–120/220–240</td><td>A</td></tr> <tr><td>200–208</td><td>D</td></tr> <tr><td>220–240</td><td>G</td></tr> <tr><td>277</td><td>L</td></tr> <tr><td>220–240/440–480</td><td>C</td></tr> <tr><td>440–480</td><td>H</td></tr> <tr><td>575–600</td><td>E</td></tr> </tbody> </table> <p>For other voltages and frequencies, see Factory Modifications page 9/119.</p>	60Hz Voltage	Letter	24	J	120	F	110–120/220–240	A	200–208	D	220–240	G	277	L	220–240/440–480	C	440–480	H	575–600
60Hz Voltage	Letter																				
24	J																				
120	F																				
110–120/220–240	A																				
200–208	D																				
220–240	G																				
277	L																				
220–240/440–480	C																				
440–480	H																				
575–600	E																				

Standard Width Enclosure, 3-Phase, 3-Pole[Ⓜ]

Max Hp				NEMA Size	Half Size	Disc Amp Rating	Fuse Clip Size Amps/Volts	Enclosure							
200 Volts	230 Volts	460 Volts	575 Volts					NEMA 1 General Purpose		NEMA 4/4X Stainless [Ⓛ] Watertight, Dust-tight Corrosion Resistant Ⓜ = W for 304 Stainless Steel Ⓧ = X for 316 Stainless Steel		NEMA 4X Fiberglass Watertight, Dust-tight Corrosion Resistant		NEMA 12, NEMA 3/3R, [Ⓛ] NEMA 4 Painted Industrial Use Weatherproof Watertight, Dust-tight	
								Catalog Number	List Price \$	Catalog Number	List Price \$	Catalog Number	List Price \$	Catalog Number	List Price \$
3	3	—	—	0	—	30	30A/250V	17CP92B*1081	17CP92@*1081	17CP92F*1081	17CP92N*1081	17CP92B*1181	17CP92@*1181	17CP92F*1181	17CP92N*1181
—	—	5	5	0	—	30	30A/600V	17CP92B*1181	17CP92@*1181	17CP92F*1181	17CP92N*1181	17CP92B*1081	17CP92@*1081	17CP92F*1081	17CP92N*1081
5	5	—	—	1	—	30	30A/250V	17DP92B*1081	17DP92@*1081	17DP92F*1081	17DP92N*1081	17DP92B*1181	17DP92@*1181	17DP92F*1181	17DP92N*1181
—	—	10	10	1	—	30	30A/600V	17DP92B*1181	17DP92@*1181	17DP92F*1181	17DP92N*1181	17DP92B*1081	17DP92@*1081	17DP92F*1081	17DP92N*1081
7½	7½	—	—	1	—	60	60A/250V	17DP92B*1281	17DP92@*1281	17DP92F*1281	17DP92N*1281	17DP92B*1181	17DP92@*1181	17DP92F*1181	17DP92N*1181
10	10	—	—	—	1¼	60	60A/250V	17EP92B*1281	17EP92@*1281	17EP92F*1281	17EP92N*1281	17EP92B*1381	17EP92@*1381	17EP92F*1381	17EP92N*1381
—	—	15	15	—	1¼	60	60A/600V	17EP92B*1381	17EP92@*1381	17EP92F*1381	17EP92N*1381	17EP92B*1281	17EP92@*1281	17EP92F*1281	17EP92N*1281
10	15	—	—	2	—	60	60A/250V	17FP92B*1281	17FP92@*1281	17FP92F*1281	17FP92N*1281	17FP92B*1381	17FP92@*1381	17FP92F*1381	17FP92N*1381
—	—	25	25	2	—	60	60A/600V	17FP92B*1381	17FP92@*1381	17FP92F*1381	17FP92N*1381	17FP92B*1281	17FP92@*1281	17FP92F*1281	17FP92N*1281
—	—	—	30	—	2½	60	60A/600V	17GP92B*1381	17GP92@*1381	17GP92F*1381	17GP92N*1381	17GP92B*1481	17GP92@*1481	17GP92F*1481	17GP92N*1481
—	—	30	—	—	2½	100	100A/600V	17GP92B*1581	17GP92@*1581	17GP92F*1581	17GP92N*1581	17GP92B*1381	17GP92@*1381	17GP92F*1381	17GP92N*1381
15	20	—	—	—	2½	100	100A/250V	17GP92B*1481	17GP92@*1481	17GP92F*1481	17GP92N*1481	17GP92B*1581	17GP92@*1581	17GP92F*1581	17GP92N*1581
20	25	—	—	3	—	100	100A/250V	17HP92B*1481	17HP92@*1481	17HP92F*1481	17HP92N*1481	17HP92B*1681	17HP92@*1681	17HP92F*1681	17HP92N*1681
—	—	50	50	3	—	100	100A/600V	17HP92B*1581	17HP92@*1581	17HP92F*1581	17HP92N*1581	17HP92B*1481	17HP92@*1481	17HP92F*1481	17HP92N*1481
25	30	—	—	3	—	200	200A/250V	17HP92B*1681	17HP92@*1681	17HP92F*1681	17HP92N*1681	17HP92B*1581	17HP92@*1581	17HP92F*1581	17HP92N*1581
30	40	—	—	—	3½	200	200A/250V	17IP92B*1681	17IP92@*1681	17IP92F*1681	17IP92N*1681	17IP92B*1781	17IP92@*1781	17IP92F*1781	17IP92N*1781
—	—	75	75	—	3½	200	200A/600V	17IP92B*1781	17IP92@*1781	17IP92F*1781	17IP92N*1781	17IP92B*1681	17IP92@*1681	17IP92F*1681	17IP92N*1681
40	50	—	—	4	—	200	200A/250V	17JP92B*1681	17JP92@*1681	17JP92F*1681	17JP92N*1681	17JP92B*1781	17JP92@*1781	17JP92F*1781	17JP92N*1781
—	—	100	100	4	—	200	200A/600V	17JP92B*1781	17JP92@*1781	17JP92F*1781	17JP92N*1781	17JP92B*1681	17JP92@*1681	17JP92F*1681	17JP92N*1681

Extra Wide Enclosure, 3-Phase, 3-Pole

Max Hp				NEMA Size	Half Size	Disc Amp Rating	Fuse Clip Size Amps/Volts	Enclosure							
200 Volts	230 Volts	460 Volts	575 Volts					NEMA 1 General Purpose		NEMA 4/4X Stainless [Ⓛ] Watertight, Dust-tight Industrial Use Weatherproof Ⓜ = W for 304 Stainless Steel Ⓧ = X for 316 Stainless Steel		NEMA 12, NEMA 3/3R, [Ⓛ] NEMA 4 Painted Industrial Use Weatherproof Watertight, Dust-tight			
								Catalog Number	List Price \$	Catalog Number	List Price \$	Catalog Number	List Price \$		
3	3	—	—	0	—	30	30A/250V	17CP82B*1081	17CP82@*1081	17CP82F*1081	17CP82N*1081	17CP82B*1181	17CP82@*1181	17CP82F*1181	17CP82N*1181
—	—	5	5	0	—	30	30A/600V	17CP82B*1181	17CP82@*1181	17CP82F*1181	17CP82N*1181	17CP82B*1081	17CP82@*1081	17CP82F*1081	17CP82N*1081
5	5	—	—	1	—	30	30A/250V	17DP82B*1081	17DP82@*1081	17DP82F*1081	17DP82N*1081	17DP82B*1181	17DP82@*1181	17DP82F*1181	17DP82N*1181
—	—	10	10	1	—	30	30A/600V	17DP82B*1181	17DP82@*1181	17DP82F*1181	17DP82N*1181	17DP82B*1081	17DP82@*1081	17DP82F*1081	17DP82N*1081
7½	7½	—	—	1	—	60	60A/250V	17DP82B*1281	17DP82@*1281	17DP82F*1281	17DP82N*1281	17DP82B*1181	17DP82@*1181	17DP82F*1181	17DP82N*1181
10	10	—	—	—	1¼	60	60A/250V	17EP82B*1281	17EP82@*1281	17EP82F*1281	17EP82N*1281	17EP82B*1381	17EP82@*1381	17EP82F*1381	17EP82N*1381
—	—	15	15	—	1¼	60	60A/600V	17EP82B*1381	17EP82@*1381	17EP82F*1381	17EP82N*1381	17EP82B*1281	17EP82@*1281	17EP82F*1281	17EP82N*1281
10	15	—	—	2	—	60	60A/250V	17FP82B*1281	17FP82@*1281	17FP82F*1281	17FP82N*1281	17FP82B*1381	17FP82@*1381	17FP82F*1381	17FP82N*1381
—	—	25	25	2	—	60	60A/600V	17FP82B*1381	17FP82@*1381	17FP82F*1381	17FP82N*1381	17FP82B*1281	17FP82@*1281	17FP82F*1281	17FP82N*1281
—	—	—	30	—	2½	60	60A/600V	17GP82B*1381	17GP82@*1381	17GP82F*1381	17GP82N*1381	17GP82B*1481	17GP82@*1481	17GP82F*1481	17GP82N*1481
—	—	30	—	—	2½	100	100A/600V	17GP82B*1581	17GP82@*1581	17GP82F*1581	17GP82N*1581	17GP82B*1381	17GP82@*1381	17GP82F*1381	17GP82N*1381
15	20	—	—	—	2½	100	100A/250V	17GP82B*1481	17GP82@*1481	17GP82F*1481	17GP82N*1481	17GP82B*1581	17GP82@*1581	17GP82F*1581	17GP82N*1581
20	25	—	—	3	—	100	100A/250V	17HP82B*1481	17HP82@*1481	17HP82F*1481	17HP82N*1481	17HP82B*1681	17HP82@*1681	17HP82F*1681	17HP82N*1681
—	—	50	50	3	—	100	100A/600V	17HP82B*1581	17HP82@*1581	17HP82F*1581	17HP82N*1581	17HP82B*1481	17HP82@*1481	17HP82F*1481	17HP82N*1481
25	30	—	—	3	—	200	200A/250V	17HP82B*1681	17HP82@*1681	17HP82F*1681	17HP82N*1681	17HP82B*1581	17HP82@*1581	17HP82F*1581	17HP82N*1581

Note: Hp's shown above are based on the overload amp range for the FLA's (per the National Electric Code) of typical industrial motors. All starter sizes carry one maximum Hp rating.

Ⓛ For conduit hubs and conversion instructions, see page 9/110.

Ⓜ Single phase wiring page 9/173.

MCP Type with Solid State Overload, Class 18

Selection

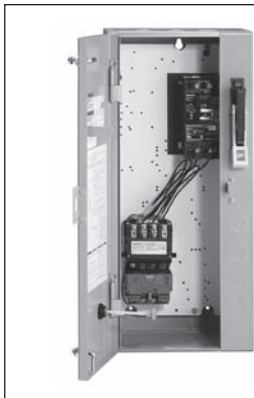

Ordering Information

Replace the (*) with a letter from the coil table. Dual voltage coils are wired on high voltage unless specified on order.
 Field Modification Kits see page 9/104.
 Factory Modifications see page 9/119.
 Dimensions see page 9/159.
 Wiring Diagrams see page 9/174.
 Replacement Parts see page 9/131.

Coil Table

60Hz Voltage	Letter
24	J
120	F
110-120/220-240 [Ⓣ]	A
200-208	D
220-240	G
277	L
220-240/440-480 [Ⓣ]	C
440-480	H
575-600	E

For other voltages and frequencies, see Factory Modifications page 9/119.

Standard Width Enclosure, 3-Phase, 3-Pole

Max Hp				NEMA Size	Half Size	Motor Circuit Interrupter ETI Amps	Overload Amp Range	Frame Size	Enclosure		NEMA 4X Fiberglass		NEMA 7 & 9 NEMA 3 & 4		NEMA 12, NEMA 3/3R [Ⓣ] , NEMA 4 Painted (thru size 4)		
200 Volts	230 Volts	460 Volts	575 Volts						NEMA 1 General Purpose	NEMA 4/4X Stainless [Ⓣ] Watertight, Dust-tight, Corrosion Resistant Ⓣ = W for 304 Stainless Steel Ⓣ = X for 316 Stainless Steel	NEMA 4X Fiberglass Watertight, Dust-tight Corrosion Resistant	NEMA 7 & 9 NEMA 3 & 4 Div. 1 and Div. 2 Class I Groups C & D Class II Groups E, F & G Class III Bolted Enclosures Indoor/Outdoor Use	NEMA 12, NEMA 3/3R [Ⓣ] , NEMA 4 Painted (thru size 4) Industrial Use Weatherproof Watertight, Dust-tight	Catalog Number	List Price \$	Catalog Number	List Price \$
1/2	1/2	1	1	0	—	3	0.75-3.4	A	18CUB92B*	18CUB92@*	18CUB92F*	18CUB92H*	18CUB92N*				
2	2	5	5	0	—	10	3-12	A1	18CUC92B*	18CUC92@*	18CUC92F*	18CUC92H*	18CUC92N*				
3	3	—	—	0	—	25	5.5-22	A1	18CUD92B*	18CUD92@*	18CUD92F*	18CUD92H*	18CUD92N*				
1/2	1/2	1	1	1	—	3	0.75-3.4	A	18DUB92B*	18DUB92@*	18DUB92F*	18DUB92H*	18DUB92N*				
2	2	5	5	1	—	10	3-12	A1	18DUC92B*	18DUC92@*	18DUC92F*	18DUC92H*	18DUC92N*				
3	3	7 1/2	10	1	—	25	5.5-22	A1	18DUD92B*	18DUD92@*	18DUD92F*	18DUD92H*	18DUD92N*				
7 1/2	7 1/2	10	—	1	—	30	10-40	A1	18DUE92B*	18DUE92@*	18DUE92F*	18DUE92H*	18DUE92N*				
—	—	15	15	—	1 1/2	40	10-40	A1	18EUE92B*	18EUE92@*	18EUE92F*	18EUE92H*	18EUE92N*				
10	15	25	25	2	—	50	13-52	B	18FUF92B*	18FUF92@*	18FUF92F*	18FUF92H*	18FUF92N*				
15	20	30	30	—	2 1/2	100	25-100	B	18GUG92B*	18GUG92@*	18GUG92F*	18GUG92H*	18GUG92N*				
25	30	50	50	3	—	125	25-100	B	18HUG92B*	18HUG92@*	18HUG92F*	18HUG92H*	18HUG92N*				
30	40	75	75	—	3 1/2	125	50-200	B	18IUH92B*	18IUH92@*	18IUH92F*	18IUH92H*	18IUH92N*				
40	50	100	100	4	—	150	50-200	B	18JUH92B*	18JUH92@*	18JUH92F*	18JUH92H*	18JUH92N*				
50	75	150	200	5	—	250	55-250	—	18LPT92B*	18LPT92E* [Ⓣ]	—	—	18LPT92H*	18LPT92N*			
75	100	200	—	5	—	400	55-250	—	18LPU92B*	18LPU92E* [Ⓣ]	—	—	—	18LPU92N*			
100	125	250	300	6	—	400	160-630	—	18MPW92B*	18MPW92E* [Ⓣ]	—	—	—	18MPW92N*			
150	200	400	400	6	—	600	160-630	—	18MPX92B*	18MPX92E* [Ⓣ]	—	—	—	18MPX92N*			
—	250	500	500	7 [Ⓣ]	—	800	400-1220	A1+CT	18NUV92B*	—	—	—	—	18NUV92N*			
—	300	600	600	7 [Ⓣ]	—	1000	400-1220	A1+CT	18NUY92B*	—	—	—	—	18NUY92N*			
—	400	800	800	8 [Ⓣ]	—	1200	400-1220	A1+CT	18PUW92B*	—	—	—	—	18PUW92N*			
—	450	900	900	8 [Ⓣ]	—	1600	400-1220	A1+CT	18PUZ92B*	—	—	—	—	18PUZ92N*			

Note: All starter sizes carry one maximum Hp rating (per the National Electric Code).

Ⓣ Dual voltage coils not available in starter sizes 5-8.

Ⓣ For conduit hubs and conversion instructions, see page 9/110.

Ⓣ Enclosure is NEMA Type 4 (painted steel).

Ⓣ F coil 100-250V AC 50/60Hz, or DC, H coil 150-500V AC 50/60Hz, or DC

Ⓣ Only available

F coil 100-250V AC 50/60Hz, or DC

MCP Type with Solid State Overload, Class 18

Selection

	Ordering Information Replace the (*) with a letter from the coil table. Dual voltage coils are wired on high voltage unless specified on order. Field Modification Kits see page 9/104. Factory Modifications see page 9/119. Dimensions see page 9/159. Wiring Diagrams see page 9/174. Replacement Parts see page 9/131.	Coil Table <table border="1"> <thead> <tr> <th>60Hz Voltage</th> <th>Letter</th> </tr> </thead> <tbody> <tr><td>24</td><td>J</td></tr> <tr><td>120</td><td>F</td></tr> <tr><td>110–120/220–240</td><td>A</td></tr> <tr><td>200–208</td><td>D</td></tr> <tr><td>220–240</td><td>G</td></tr> <tr><td>277</td><td>L</td></tr> <tr><td>220–240/440–480</td><td>C</td></tr> <tr><td>440–480</td><td>H</td></tr> <tr><td>575–600</td><td>E</td></tr> </tbody> </table> For other voltages and frequencies, see Factory Modifications page 9/119.	60Hz Voltage	Letter	24	J	120	F	110–120/220–240	A	200–208	D	220–240	G	277	L	220–240/440–480	C	440–480	H	575–600	E
	60Hz Voltage	Letter																				
24	J																					
120	F																					
110–120/220–240	A																					
200–208	D																					
220–240	G																					
277	L																					
220–240/440–480	C																					
440–480	H																					
575–600	E																					

Extra Wide Enclosure, 3-Phase, 3-Pole

Max Hp				NEMA Size	Half Size	Motor Circuit Interrupter ETI Amps	Overload		Enclosure					
200 Volts	230 Volts	460 Volts	575 Volts				Amp Range	Frame Size	NEMA 1 General Purpose		NEMA 4/4X Stainless [Ⓞ] Watertight, Dust-tight, Corrosion Resistant Ⓞ = W for 304 Stainless Steel Ⓞ = X for 316 Stainless Steel		NEMA 12, NEMA 3/3R [Ⓞ] , NEMA 4 Painted Industrial Use Weatherproof Watertight, Dust-tight	
									Catalog Number	List Price \$	Catalog Number	List Price \$	Catalog Number	List Price \$
1/2	1/2	1	1	0	—	3	0.75–3.4	A	18CUB82B*		18CUB82@*		18CUB82N*	
2	2	5	5	0	—	10	3–12	A1	18CUC82B*		18CUC82@*		18CUC82N*	
3	3	—	—	0	—	25	5.5–22	A1	18CUD82B*		18CUD82@*		18CUD82N*	
1/2	1/2	1	1	1	—	3	0.75–3.4	A	18DUB82B*		18DUB82@*		18DUB82N*	
2	2	5	5	1	—	10	3–12	A1	18DUC82B*		18DUC82@*		18DUC82N*	
3	3	7 1/2	10	1	—	25	5.5–22	A1	18DUD82B*		18DUD82@*		18DUD82N*	
7 1/2	7 1/2	10	—	1	—	30	10–40	A1	18DUE82B*		18DUE82@*		18DUE82N*	
—	—	15	15	—	1 1/2	40	10–40	A1	18EUE82B*		18EUE82@*		18EUE82N*	
10	15	25	25	2	—	50	13–52	B	18FUF82B*		18FUF82@*		18FUF82N*	
15	20	30	30	—	2 1/2	100	25–100	B	18GUG82B*		18GUG82@*		18GUG82N*	
25	30	50	50	3	—	125	25–100	B	18HUG82B*		18HUG82@*		18HUG82N*	

Note: All starter sizes carry one maximum Hp rating (per the National Electric Code).

Ⓞ For conduit hubs and conversion instructions, see page 9/110.

MCP Type with Ambient Compensated Bimetal Overload, Class 18

Selection

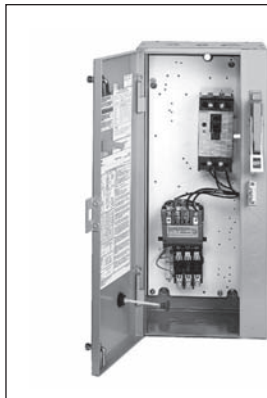

Ordering Information

Replace the (*) with a letter from the coil table. Dual voltage coils are wired on high voltage unless specified on order.
 Heater elements see page 9/124. (3 required)
 Field Modification Kits see page 9/104.
 Factory Modifications see page 9/119.
 Dimensions see page 9/159.
 Wiring Diagrams see page 9/174.
 Replacement Parts see page 9/131.
 For NO/NC SPDT contact on overload relay, replace "81" with "91".
 "81" indicates one NC contact.

Coil Table

60Hz Voltage	Letter
24	J
120	F
110–120/220–240	A
200–208	D
220–240	G
277	L
220–240/440–480	C
440–480	H
575–600	E

For other voltages and frequencies, see Factory Modifications page 9/119.

Standard Width Enclosure, 3-Phase, 3-Pole

Max Hp				NEMA Size	Half Size	Motor Circuit Interrupter ETI Amps	Enclosure				
200 Volts	230 Volts	460 Volts	575 Volts				NEMA 1 General Purpose Watertight, Dust-tight	NEMA 4/4X Stainless [Ⓞ] Watertight, Dust-tight Corrosion Resistant Ⓞ = W for 304 Stainless Steel Ⓞ = X for 316 Stainless Steel	NEMA 4X Fiberglass NEMA 3 & 4 Corrosion Resistant Class I Groups C & D Class II Groups E, F & G	NEMA 7 & 9 Div 1 and Div 2 Weatherproof Watertight, Dust-tight Class III Bolted Enclosures Indoor/Outdoor Use	NEMA 12, NEMA 3/3R, [Ⓞ] NEMA 4 Painted Industrial Use
Catalog Number	List Price \$	Catalog Number	List Price \$	Catalog Number	List Price \$	Catalog Number	List Price \$	Catalog Number	List Price \$	Catalog Number	List Price \$
1/2	1/2	1	1	0	—	3	18CP92BA*81	18CP92@A*81	18CP92FA*81	18CP92HA*81	18CP92NA*81
1	1	3	3	0	—	10	18CP92BB*81	18CP92@B*81	18CP92FB*81	18CP92HB*81	18CP92NB*81
3	3	5	5	0	—	25	18CP92BC*81	18CP92@C*81	18CP92FC*81	18CP92HC*81	18CP92NC*81
1/2	1/2	1	1	1	—	3	18DP92BA*81	18DP92@A*81	18DP92FA*81	18DP92HA*81	18DP92NA*81
1	1	3	3	1	—	10	18DP92BB*81	18DP92@B*81	18DP92FB*81	18DP92HB*81	18DP92NB*81
3	3	7 1/2	7 1/2	1	—	25	18DP92BD*81	18DP92@D*81	18DP92FD*81	18DP92HD*81	18DP92ND*81
7 1/2	7 1/2	10	10	1	—	30	18DP92BE*81	18DP92@E*81	18DP92FE*81	18DP92HE*81	18DP92NE*81
—	—	15	15	—	1 1/4	40	18EP92BF*81	18EP92@F*81	18EP92FF*81	18EP92HF*81	18EP92NF*81
10	10	—	—	—	1 1/4	50	18EP92BG*81	18EP92@G*81	18EP92FG*81	18EP92HG*81	18EP92NG*81
—	—	20	20	2	—	40	18FP92BH*81	18FP92@H*81	18FP92FH*81	18FP92HH*81	18FP92NH*81
10	15	25	25	2	—	50	18FP92BJ*81	18FP92@J*81	18FP92FJ*81	18FP92HJ*81	18FP92NJ*81
10	15	30	30	—	2 1/2	50	18GP92BK*81	18GP92@K*81	18GP92FK*81	18GP92HK*81	18GP92NK*81
15	20	—	—	—	2 1/2	100	18GP92BL*81	18GP92@L*81	18GP92FL*81	18GP92HL*81	18GP92NL*81
—	—	30	30	3	—	50	18HP92BM*81	18HP92@M*81	18HP92FM*81	18HP92HM*81	18HP92NM*81
25	30	50	50	3	—	125	18HP92BN*81	18HP92@N*81	18HP92FN*81	18HP92HN*81	18HP92NN*81
30	40	75	75	—	3 1/2	125	18IP92BP*81	18IP92@P*81	18IP92FP*81	18IP92HP*81	18IP92NP*81
40	50	100	100	4	—	150	18JP92BR*81	18JP92@R*81	18JP92FR*81	18JP92HR*81	18JP92NR*81

Extra Wide Enclosure, 3-Phase, 3-Pole

Max Hp				NEMA Size	Half Size	Motor Circuit Interrupter ETI Amps	Enclosure			
200 Volts	230 Volts	460 Volts	575 Volts				NEMA 1 General Purpose	NEMA 4/4X Stainless [Ⓞ] Watertight, Dust-tight Corrosion Resistant Ⓞ=W for 304 Stainless Steel Ⓞ=X for 316 Stainless Steel	NEMA 12, NEMA 3/3R, [Ⓞ] NEMA 4 Painted Industrial Use Weatherproof Watertight, Dust-tight	
Catalog Number	List Price \$	Catalog Number	List Price \$	Catalog Number	List Price \$	Catalog Number	List Price \$			
1/2	1/2	1	1	0	—	3	18CP82BA*81	18CP82@A*81	18CP82NA*81	
1	1	3	3	0	—	10	18CP82BB*81	18CP82@B*81	18CP82NB*81	
3	3	5	5	0	—	25	18CP82BC*81	18CP82@C*81	18CP82NC*81	
1/2	1/2	1	1	1	—	3	18DP82BA*81	18DP82@A*81	18DP82NA*81	
1	1	3	3	1	—	10	18DP82BB*81	18DP82@B*81	18DP82NB*81	
3	3	7 1/2	7 1/2	1	—	25	18DP82BD*81	18DP82@D*81	18DP82ND*81	
7 1/2	7 1/2	10	10	1	—	30	18DP82BE*81	18DP82@E*81	18DP82NE*81	
—	—	15	15	—	1 1/4	40	18EP82BF*81	18EP82@F*81	18EP82NF*81	
10	10	—	—	—	1 1/4	50	18EP82BG*81	18EP82@G*81	18EP82NG*81	
—	—	20	20	2	—	40	18FP82BH*81	18FP82@H*81	18FP82NH*81	
10	15	25	25	2	—	50	18FP82BJ*81	18FP82@J*81	18FP82NJ*81	
10	15	30	30	—	2 1/2	50	18GP82BK*81	18GP82@K*81	18GP82NK*81	
15	20	—	—	—	2 1/2	100	18GP82BL*81	18GP82@L*81	18GP82NL*81	
—	—	30	30	3	—	50	18HP82BM*81	18HP82@M*81	18HP82NM*81	
25	30	50	50	3	—	125	18HP82BN*81	18HP82@N*81	18HP82NN*81	

Note: Hp's shown above are based on the overload amp range for the FLA's (per the National Electric Code) of typical industrial motors. All starter sizes carry one maximum Hp rating.

Ⓞ For conduit hubs and conversion instructions, see page 9/110.

Solid State Overload, Class 22

Selection

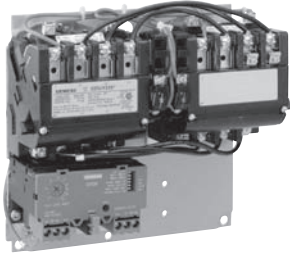

Ordering Information

Replace the (*) with a letter from the coil table. Dual voltage coils are wired on high voltage unless specified on order.
 Field Modification Kits see page 9/104.
 Factory Modifications see page 9/119.
 Dimensions see page 9/142 open and 9/162 enclosed.
 Wiring Diagrams see page 9/176.

Coil Table

60Hz Voltage	Letter
24	J
120	F
110–120/220–240 ^①	A
200–208	D
220–240	G
277	L
220–240/440–480 ^①	C
440–480	H
575–600	E

For other voltages and frequencies, see Factory Modifications page 9/119.

Open Type & Standard Width Enclosure, 3-Phase, 3-Pole

Max Hp				NEMA Size	Half Size	Amp Range	Frame Size	Enclosure											
200 Volts	230 Volts	460 Volts	575 Volts					Open Type Standard Auxiliary Contacts ^⑥		NEMA 1 General Purpose		NEMA 4/4X Stainless ^⑦ Watertight, Dust-tight, Corrosion Resistant 304 Stainless Steel		NEMA 4X Fiberglass Watertight, Dust-tight Corrosion Resistant		NEMA 7 & 9 NEMA 3 & 4 Div. 1 and Div. 2 Class I Groups C & D Class II Groups E, F & G Class III Bolted Enclosures Indoor/ Outdoor Use		NEMA 12 NEMA 3/3R ^⑧ Industrial Use Weatherproof (Field Convertible to 3/3R)	
Catalog Number	List Price \$	Catalog Number	List Price \$	Catalog Number	List Price \$	Catalog Number	List Price \$	Catalog Number	List Price \$	Catalog Number	List Price \$	Catalog Number	List Price \$	Catalog Number	List Price \$	Catalog Number	List Price \$		
1/4	1/4	1/4	1/2	00	—	0.25–1	A	22BUA32A*	22BUA32B*	Use Size 0	—	22CUA32W*	22CUA32F*	22DUA32H*	22EUA32H*	22NUN320*	22PUN320*		
1/2	1/2	1 1/2	2	00	—	0.75–3.4	A	22BUB32A*	22BUB32B*	Use Size 0	—	22CUB32W*	22CUB32F*	22DUB32H*	22EUB32H*	22NUN320*	22PUN320*		
1 1/2	1 1/2	2	—	00	—	3–12	A1	22BUC32A*	22BUC32B*	Use Size 0	—	22CUC32W*	22CUC32F*	22DUC32H*	22EUC32H*	22NUN320*	22PUN320*		
1/4	1/4	1/2	1/2	0	—	0.25–1	A	22CUA32A*	22CUA32B*	22CUA32W*	—	22CUA32W*	22CUA32F*	22DUA32H*	22EUA32H*	22NUN320*	22PUN320*		
1/2	1/2	1 1/2	2	0	—	0.75–3.4	A	22CUB32A*	22CUB32B*	22CUB32W*	—	22CUB32W*	22CUB32F*	22DUB32H*	22EUB32H*	22NUN320*	22PUN320*		
2	2	5	5	0	—	3–12	A1	22CUC32A*	22CUC32B*	22CUC32W*	—	22CUC32W*	22CUC32F*	22DUC32H*	22EUC32H*	22NUN320*	22PUN320*		
3	3	—	—	0	—	5.5–22	A1	22CUD32A*	22CUD32B*	22CUD32W*	—	22CUD32W*	22CUD32F*	22DUC32H*	22EUC32H*	22NUN320*	22PUN320*		
1/4	1/4	1/2	1/2	1	—	0.25–1	A	22DUA32A*	22DUA32B*	22DUA32W*	—	22DUA32W*	22DUA32F*	22DUA32H*	22EUA32H*	22NUN320*	22PUN320*		
1/2	1/2	1 1/2	2	1	—	0.75–3.4	A	22DUB32A*	22DUB32B*	22DUB32W*	—	22DUB32W*	22DUB32F*	22DUB32H*	22EUB32H*	22NUN320*	22PUN320*		
2	2	5	5	1	—	3–12	A1	22DUC32A*	22DUC32B*	22DUC32W*	—	22DUC32W*	22DUC32F*	22DUC32H*	22EUC32H*	22NUN320*	22PUN320*		
3	3	10	10	1	—	5.5–22	A1	22DUD32A*	22DUD32B*	22DUD32W*	—	22DUD32W*	22DUD32F*	22DUD32H*	22EUD32H*	22NUN320*	22PUN320*		
7 1/2	7 1/2	—	—	1	—	10–40	A1	22DUE32A*	22DUE32B*	22DUE32W*	—	22DUE32W*	22DUE32F*	22DUE32H*	22EUE32H*	22NUN320*	22PUN320*		
10	10	15	15	—	1 1/4	10–40	A1	22EUE32A*	22EUE32B*	22EUE32W*	—	22EUE32W*	22EUE32F*	22EUE32H*	22EUE32H*	22NUN320*	22PUN320*		
10	15	25	25	2	—	13–52	B	22FUF32A*	22FUF32B*	22FUF32W*	—	22FUF32W*	22FUF32F*	22FUF32H*	22FUF32H*	22NUN320*	22PUN320*		
15	20	30	30	—	2 1/2	25–100	B	22GUG32A*	22GUG32B*	22GUG32W*	—	22GUG32W*	22GUG32F*	22GUG32H*	22GUG32H*	22NUN320*	22PUN320*		
25	30	50	50	3	—	25–100	B	22HUG32A*	22HUG32B*	22HUG32W*	—	22HUG32W*	22HUG32F*	22HUG32H*	22HUG32H*	22NUN320*	22PUN320*		
30	40	75	75	—	3 1/2	50–200	B	22IUH32A*	22IUH32B*	22IUH32W*	—	22IUH32W*	22IUH32F*	22IUH32H*	22IUH32H*	22NUN320*	22PUN320*		
40	50	100	100	4	—	50–200	B	22JUH32A*	22JUH32B*	22JUH32W*	—	22JUH32W*	22JUH32F*	22JUH32H*	22JUH32H*	22NUN320*	22PUN320*		
75	100	200	200	5	—	55–250	—	22LPU32A*	22LPU32B*	22LPU32E* ^③	—	22LPU32E* ^③	—	—	—	22LPU320*	22PUN320*		
150	200	400	400	6	—	160–630	—	22MPX32A*	22MPX32B*	22MPX32E* ^③	—	22MPX32E* ^③	—	—	—	22MPX320*	22PUN320*		
—	300	600	600	7 ^④	—	400–1220	A1+CT	22NUN32A*	22NUN32B*	—	—	—	—	—	—	22NUN320*	22PUN320*		
—	450	900	900	8 ^⑤	—	400–1220	A1+CT	22PUN32A*	22PUN32B*	—	—	—	—	—	—	22PUN320*	22PUN320*		

Note: All starter sizes carry one maximum Hp rating (per the National Electric Code).

- ① Dual voltage coils not available in size 5–8 starters.
- ② For conduit hubs and conversion instructions, see page 9/110.

- ③ Enclosure is rated only NEMA 4 (painted steel).
- ④ Only available
F coil 100–250V AC 50/60Hz, or DC
H coil 150–500V AC 50/60Hz, or DC
- ⑤ Only available
F coil 100–250V AC 50/60Hz, or DC

- ⑥ Auxiliary contacts
22B–22E 4th pole built-in
22F–22J 2 NO & 2 NC

Ambient Compensated Bimetal Overload with Manual and Auto Reset, Class 22

Selection

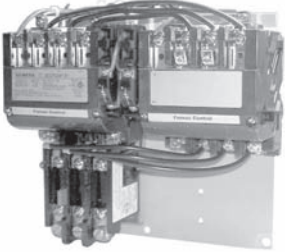
	Ordering Information	Coil Table																			
	<p>Replace the (*) with a letter from the coil table. Dual voltage coils are wired on high voltage unless specified on order.</p> <p>Heater elements see page 9/124. Single phase starters require 1 heater element. 3-phase starters require 3 heater elements.</p> <p>Field Modification Kits see page 9/104.</p> <p>Factory Modifications see page 9/119.</p> <p>Dimensions see pages 9/142 open and 9/162 enclosed.</p> <p>Wiring Diagrams see page 9/175.</p> <p>Replacement Parts see page 9/131.</p> <p>For NO/NC SPDT contact on overload relay, replace "81" with "91". "81" indicates one NC contact.</p>	<table border="1"> <thead> <tr> <th>60Hz Voltage</th> <th>Letter</th> </tr> </thead> <tbody> <tr><td>24</td><td>J</td></tr> <tr><td>120</td><td>F</td></tr> <tr><td>110–120/220–240</td><td>A</td></tr> <tr><td>200–208</td><td>D</td></tr> <tr><td>220–240</td><td>G</td></tr> <tr><td>277</td><td>L</td></tr> <tr><td>220–240/440–480</td><td>C</td></tr> <tr><td>440–480</td><td>H</td></tr> <tr><td>575–600</td><td>E</td></tr> </tbody> </table> <p>For other voltages and frequencies, see Factory Modifications page 9/119.</p>	60Hz Voltage	Letter	24	J	120	F	110–120/220–240	A	200–208	D	220–240	G	277	L	220–240/440–480	C	440–480	H	575–600
60Hz Voltage	Letter																				
24	J																				
120	F																				
110–120/220–240	A																				
200–208	D																				
220–240	G																				
277	L																				
220–240/440–480	C																				
440–480	H																				
575–600	E																				

Open Type & Standard Width Enclosure, 3-Phase, 3-Pole

Max Hp				Enclosure														
200 Volts	230 Volts	460 Volts	575 Volts	Contactor Amp Rating	NEMA Size	Half Size	Open Type ^③		NEMA 1 General Purpose		NEMA 4/4X Stainless ^① Watertight, Dust-tight Corrosion Resistant 304 Stainless Steel		NEMA 4X Fiberglass Watertight, Dust-tight Corrosion Resistant Indoor/Outdoor Use		NEMA 7 & 9 NEMA 3 & 4 Div 1 and Div 2 Class I Groups C & D Class II Groups E, F & G Class III Bolted Enclosures		NEMA 12 ^① NEMA 3/3R Industrial Use Weatherproof	
							Catalog Number	List Price \$	Catalog Number	List Price \$	Catalog Number	List Price \$	Catalog Number	List Price \$	Catalog Number	List Price \$	Catalog Number	List Price \$
1 1/2	1 1/2	2	2	9	00	—	22BP32A*81	22BP32B*81	Use Size 0	—	Use Size 0	—	Use Size 0	—	Use Size 0	—	Use Size 0	—
3	3	5	5	18	0	—	22CP32A*81	22CP32B*81	22CP32W*81	—	22CP32F*81	—	22CP32H*81	—	22CP32J*81	—	22CP32K*81	—
7 1/2	7 1/2	10	10	27	1	—	22DP32A*81	22DP32B*81	22DP32W*81	—	22DP32F*81	—	22DP32H*81	—	22DP32J*81	—	22DP32K*81	—
10	10	15	15	40	—	1 3/4	22EP32A*81	22EP32B*81	22EP32W*81	—	22EP32F*81	—	22EP32H*81	—	22EP32J*81	—	22EP32K*81	—
10	15	25	25	45	2	—	22FP32A*81	22FP32B*81	22FP32W*81	—	22FP32F*81	—	22FP32H*81	—	22FP32J*81	—	22FP32K*81	—
15	20	30	30	60	—	2 1/2	22GP32A*81	22GP32B*81	22GP32W*81	—	22GP32F*81	—	22GP32H*81	—	22GP32J*81	—	22GP32K*81	—
25	30	50	50	90	3	—	22HP32A*81	22HP32B*81	22HP32W*81	—	22HP32F*81	—	22HP32H*81	—	22HP32J*81	—	22HP32K*81	—
30	40	75	75	115	—	3 1/2	22IP32A*81	22IP32B*81	22IP32W*81	—	22IP32F*81	—	22IP32H*81	—	22IP32J*81	—	22IP32K*81	—
40	50	100	100	135	4	—	22JG32A*81	22JG32B*81	22JG32W*81	—	22JG32F*81	—	22JG32H*81	—	22JG32J*81	—	22JG32K*81	—

Open Type & Standard Width Enclosure, Single Phase, 3-Wire, 2-Pole^②

Max Hp				Enclosure											
115 Volts	208/230 Volts	Contactor Amp Rating	NEMA Size	Open Type		NEMA 1 General Purpose		NEMA 4/4X Stainless ^① Watertight, Dust-tight Corrosion Resistant 304 Stainless Steel		NEMA 4X Fiberglass Watertight, Dust-tight Corrosion Resistant		NEMA 7 & 9 NEMA 3 & 4 Div 1 and Div 2 Class I Groups C & D Class II Groups E, F & G Class III Bolted Enclosures Indoor/Outdoor Use		NEMA 12 ^① NEMA 3/3R Industrial Use Weatherproof	
				Catalog Number	List Price \$	Catalog Number	List Price \$	Catalog Number	List Price \$	Catalog Number	List Price \$	Catalog Number	List Price \$	Catalog Number	List Price \$
1/2	1	9	00	22BP12A*81	22BP12B*81	Use Size 0	—	Use Size 0	—	Use Size 0	—	Use Size 0	—	Use Size 0	—
1	2	18	0	22CP12A*81	22CP12B*81	22CP12W*81	—	22CP12F*81	—	22CP12H*81	—	22CP12J*81	—	22CP12K*81	—
2	3	27	1	22DP12A*81	22DP12B*81	22DP12W*81	—	22DP12F*81	—	22DP12H*81	—	22DP12J*81	—	22DP12K*81	—
3	5	35	1P	22EP12A*81	22EP12B*81	22EP12W*81	—	22EP12F*81	—	22EP12H*81	—	22EP12J*81	—	22EP12K*81	—

Note: Hp's shown above are based on the overload amp range for the FLA's (per the National Electric Code) of typical industrial motors. All Starter Sizes carry one maximum Hp rating.

① For conduit hubs and conversion instructions, see page 9/110.

② Coil D, F, or G will be wired for Incoming Voltage. J coil will be wired for 24V separate source. Coils E, H, and L do not apply to single phase starters.

③ Auxiliary contacts 22B-22E 4th pole built-in 22F-22J 2 NO & 2 NC

Non-Fusible, Class 25

Selection

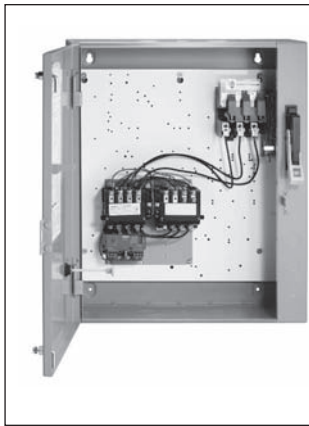

Ordering Information

Replace the (*) with a letter from the coil table. Dual voltage coils are wired on high voltage unless specified on order.
 Heater elements see page 9/124.
 Fuse clips see page 9/120.
 Field Modification Kits see page 9/104.
 Factory Modifications see page 9/119.
 Dimensions see page 9/164.
 Wiring Diagrams see page 9/177.
 Replacement Parts see page 9/131.
 For NO/NC SPDT contact on overload, replace "81" with "91".
 "81" indicates one NC contact.

Coil Table

60Hz Voltage	Letter
24	J
120	F
110-120/220-240 ^①	A
200-208	D
220-240	G
277	L
220-240/440-480 ^①	C
440-480	H
575-600	E

For other voltages and frequencies, see Factory Modifications page 9/119.

Standard Width Enclosure with Solid State Overload, 3-Phase, 3-Pole

Max Hp				NEMA Size	Half Size	Overload		Disc. Amp Rating	Enclosure							
200 Volts	230 Volts	460 Volts	575 Volts			Amp Range	Frame Size		NEMA 1 General Purpose	NEMA 4/4X Stainless ^② Watertight, Dust-tight, Corrosion Resistant 304 Stainless Steel		NEMA 4X Fiberglass Watertight, Dust-tight Corrosion Resistant		NEMA 12, NEMA 3/3R ^③ , NEMA 4 Painted (thru size 4) Industrial Use Weatherproof Watertight, Dust-tight		
Catalog Number		List Price \$		Catalog Number		List Price \$		Catalog Number		List Price \$		Catalog Number		List Price \$		
1/2	1/2	1/2	1/2	0	—	0.25-1	A	30	25CUA92B*	25CUA92W*	25CUA92F*	25CUA92N*				
1/2	3/4	1 1/2	2	0	—	0.75-3.4	A	30	25CUB92B*	25CUB92W*	25CUB92F*	25CUB92N*				
2	2	5	5	0	—	3-12	A1	30	25CUC92B*	25CUC92W*	25CUC92F*	25CUC92N*				
3	3	—	—	0	—	5.5-22	A1	30	25CUD92B*	25CUD92W*	25CUD92F*	25CUD92N*				
1/2	3/4	1 1/2	2	1	—	0.25-1	A	30	25DUA92B*	25DUA92W*	25DUA92F*	25DUA92N*				
1/2	2	5	5	1	—	0.75-3.4	A	30	25DUB92B*	25DUB92W*	25DUB92F*	25DUB92N*				
2	2	5	5	1	—	3-12	A1	30	25DUC92B*	25DUC92W*	25DUC92F*	25DUC92N*				
3	3	10	10	1	—	5.5-22	A1	30	25DUD92B*	25DUD92W*	25DUD92F*	25DUD92N*				
7 1/2	7 1/2	—	—	1	—	10-40	A1	60	25DUE92B*	25DUE92W*	25DUE92F*	25DUE92N*				
10	10	15	15	—	1 1/2	10-40	A1	60	25EUE92B*	25EUE92W*	25EUE92F*	25EUE92N*				
10	15	25	25	2	—	13-52	B	60	25FUF92B*	25FUF92W*	25FUF92F*	25FUF92N*				
15	20	30	30	—	2 1/2	25-100	B	100	25GUG92B*	25GUG92W*	25GUG92F*	25GUG92N*				
20	25	50	50	3	—	25-100	B	100	25HUG92B*	25HUG92W*	25HUG92F*	25HUG92N*				
30	40	75	75	—	3 1/2	50-200	B	200	25IUH92B*	25IUH92W*	25IUH92F*	25IUH92N*				
40	50	100	100	4	—	50-200	B	200	25JUH92B*	25JUH92W*	25JUH92F*	25JUH92N*				
75	100	200	200	5	—	55-250	—	400	25LPU92B*	25LPU92E* ^⑤	—	25LPU92N*				
150	200	400	400	6	—	160-630	—	600	25MPX92B*	25MPX92E* ^⑤	—	25MPX92N*				
—	300	600	600	7 ^④	—	400-1220	A1+CT	1200	25NUN92B*	—	—	25NUN92N*				
—	450	900	900	8 ^④	—	400-1220	A1+CT	1600	25PUN92B*	—	—	25PUN92N*				

Standard Width Enclosure with Ambient Compensated Bimetal Overload, 3-Phase, 3-Pole

Max Hp				NEMA Size	Half Size	Disc. Amp Rating	Enclosure								
200 Volts	230 Volts	460 Volts	575 Volts				NEMA 1 General Purpose	NEMA 4/4X Stainless ^② Watertight, Dust-tight Corrosion Resistant 304 Stainless Steel		NEMA 4X Fiberglass Watertight, Dust-tight Corrosion Resistant		NEMA 12 ^② NEMA 3/3R NEMA 4 Painted Industrial Use Weatherproof Watertight, Dust-tight			
Catalog Number		List Price \$		Catalog Number		List Price \$		Catalog Number		List Price \$		Catalog Number		List Price \$	
3	3	5	5	0	—	30	25CP92B*81	25CP92W*81	25CP92F*81	25CP92N*81					
7 1/2	7 1/2	10	10	1	—	30	25DP92B*81	25DP92W*81	25DP92F*81	25DP92N*81					
10	10	15	15	—	1 1/4	60	25EP92B*81	25EP92W*81	25EP92F*81	25EP92N*81					
10	15	25	25	2	—	60	25FP92B*81	25FP92W*81	25FP92F*81	25FP92N*81					
15	20	30	30	—	2 1/2	100	25GP92B*81	25GP92W*81	25GP92F*81	25GP92N*81					
25	30	50	50	3	—	100	25HP92B*81	25HP92W*81	25HP92F*81	25HP92N*81					
30	40	75	75	—	3 1/2	200	25IP92B*81	25IP92W*81	25IP92F*81	25IP92N*81					
40	50	100	100	4	—	200	25JP92B*81	25JP92W*81	25JP92F*81	25JP92N*81					

Note: All starter sizes carry one maximum Hp rating (per the National Electric Code).

① Dual voltage coils not available in starter sizes 5-8.

② For conduit hubs and conversion instructions, see page 9/110.

③ Enclosure is NEMA Type 4 (painted steel).

④ F coil 100-250V AC 50/60Hz, or DC, H coil 150-500V AC 50/60Hz, or DC

⑤ Only available F coil 100-250V AC 50/60Hz, or DC

MCP Type, Class 26

Selection

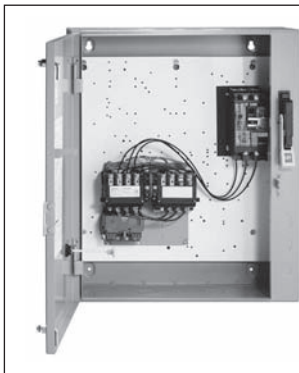

Ordering Information

Replace the (*) with a letter from the coil table. Dual voltage coils are wired on high voltage unless specified on order.

Field Modification Kits see page 9/104.

Factory Modifications see page 9/119.

Dimensions see page 9/164.

Wiring Diagrams see page 9/177.

Replacement Parts see page 9/131.

For NO/NC SPDT contact on overload relay, replace "81" with "91".
"81" indicates one NC contact.

Coil Table

60Hz Voltage	Letter
24	J
120	F
110–120/220–240 [ⓐ]	A
200–208	D
220–240	G
277	L
220–240/440–480 [ⓐ]	C
440–480	H
575–600	E

For other voltages and frequencies, see Factory Modifications page 9/119.

Standard Width Enclosure with Solid State Overload, 3-Phase, 3-Pole

Max Hp				NEMA Size	Half Size	Motor Circuit Interrupter ETI Amps	Overload Amp Range	Frame Size	Enclosure									
200 Volts	230 Volts	460 Volts	575 Volts						NEMA 1 General Purpose		NEMA 4/4X Stainless [ⓐ] Watertight, Dust-tight, Corrosion Resistant 304 Stainless Steel		NEMA 4X Fiberglass Watertight, Dust-tight Corrosion Resistant		NEMA 7 & 9 NEMA 3 & 4 Div. 1 and Div. 2 Class I Groups C & D Class II Groups E, F & G Class III Bolted Enclosures Indoor/Outdoor Use		NEMA 12, NEMA 3/3R [ⓐ] , NEMA 4 Painted (thru size 4) Industrial Use Weatherproof Watertight, Dust-tight	
Catalog Number	List Price \$	Catalog Number	List Price \$						Catalog Number	List Price \$	Catalog Number	List Price \$	Catalog Number	List Price \$	Catalog Number	List Price \$	Catalog Number	List Price \$
1/2	1/2	1	1	0	—	3	0.75–3.4	A	26CUB92B*	26CUB92W*	26CUB92F*	26CUB92H*	26CUB92N*					
2	2	5	5	0	—	10	3–12	A1	26CUC92B*	26CUC92W*	26CUC92F*	26CUC92H*	26CUC92N*					
3	3	—	—	0	—	25	5.5–22	A1	26CUD92B*	26CUD92W*	26CUD92F*	26CUD92H*	26CUD92N*					
1/2	1/2	1	1	1	—	3	0.75–3.4	A	26DUB92B*	26DUB92W*	26DUB92F*	26DUB92H*	26DUB92N*					
2	2	5	5	1	—	10	3–12	A1	26DUC92B*	26DUC92W*	26DUC92F*	26DUC92H*	26DUC92N*					
3	3	7 1/2	10	1	—	25	5.5–22	A1	26DUD92B*	26DUD92W*	26DUD92F*	26DUD92H*	26DUD92N*					
7 1/2	7 1/2	10	—	1	—	30	10–40	A1	26DUE92B*	26DUE92W*	26DUE92F*	26DUE92H*	26DUE92N*					
—	—	15	15	—	1 1/4	40	10–40	A1	26EUE92B*	26EUE92W*	26EUE92F*	26EUE92H*	26EUE92N*					
10	15	25	25	2	—	50	13–52	B	26FUF92B*	26FUF92W*	26FUF92F*	26FUF92H*	26FUF92N*					
15	20	30	30	—	2 1/2	100	25–100	B	26GUG92B*	26GUG92W*	26GUG92F*	26GUG92H*	26GUG92N*					
25	30	50	50	3	—	125	25–100	B	26HUG92B*	26HUG92W*	26HUG92F*	26HUG92H*	26HUG92N*					
30	40	75	75	—	3 1/2	125	50–200	B	26IUH92B*	26IUH92W*	26IUH92F*	26IUH92H*	26IUH92N*					
40	50	100	100	4	—	150	50–200	B	26JUH92B*	26JUH92W*	26JUH92F*	26JUH92H*	26JUH92N*					
50	75	150	200	5	—	250	55–250	—	26LPT92B*	26LPT92E* [ⓐ]	—	—	26LPT92N*					
75	100	200	—	5	—	400	55–250	—	26LP92B*	26LP92E* [ⓐ]	—	—	26LP92N*					
100	125	250	300	6	—	400	160–630	—	26MPW92B*	26MPW92E* [ⓐ]	—	—	26MPW92N*					
150	200	400	400	6	—	600	160–630	—	26MPX92B*	26MPX92E* [ⓐ]	—	—	26MPX92N*					
—	250	500	500	7* [ⓐ]	—	800	400–1220	A1+CT	26NUV92B*	—	—	—	26NUV92N*					
—	300	600	600	7* [ⓐ]	—	1000	400–1220	A1+CT	26NUY92B*	—	—	—	26NUY92N*					
—	400	800	800	8 [ⓐ]	—	1200	400–1220	A1+CT	26PUW92B*	—	—	—	26PUW92N*					
—	450	900	900	8 [ⓐ]	—	1600	400–1220	A1+CT	26PUZ92B*	—	—	—	26PUZ92N*					

Standard Width Enclosure with Ambient Compensated Bimetal Overload, 3-Phase, 3-Pole

1/2	1/2	1	1	0	—	3	26CP92BA*81	26CP92WA*81	26CP92FA*81	26CP92HA*81	26CP92NA*81
1	1	3	3	0	—	10	26CP92BB*81	26CP92WB*81	26CP92FB*81	26CP92HB*81	26CP92NB*81
3	3	5	5	0	—	25	26CP92BC*81	26CP92WC*81	26CP92FC*81	26CP92HC*81	26CP92NC*81
1/2	1/2	1	1	1	—	3	26DP92BA*81	26DP92WA*81	26DP92FA*81	26DP92HA*81	26DP92NA*81
1	1	3	3	1	—	10	26DP92BB*81	26DP92WB*81	26DP92FB*81	26DP92HB*81	26DP92NB*81
3	3	7 1/2	7 1/2	1	—	25	26DP92BD*81	26DP92WD*81	26DP92FD*81	26DP92HD*81	26DP92ND*81
7 1/2	7 1/2	10	10	1	—	30	26DP92BE*81	26DP92WE*81	26DP92FE*81	26DP92HE*81	26DP92NE*81
—	—	15	15	—	1 1/4	40	26EP92BF*81	26EP92WF*81	26EP92FF*81	26EP92HF*81	26EP92NF*81
10	10	—	—	—	1 1/4	50	26EP92BG*81	26EP92WG*81	26EP92FG*81	26EP92HG*81	26EP92NG*81
—	—	20	20	2	—	40	26FP92BH*81	26FP92WH*81	26FP92FH*81	26FP92HH*81	26FP92NH*81
10	15	25	25	2	—	50	26FP92BJ*81	26FP92WJ*81	26FP92FJ*81	26FP92HJ*81	26FP92NJ*81
10	15	30	30	—	2 1/2	50	26GP92BK*81	26GP92WK*81	26GP92FK*81	26GP92HK*81	26GP92NK*81
15	20	—	—	—	2 1/2	100	26GP92BL*81	26GP92WL*81	26GP92FL*81	26GP92HL*81	26GP92NL*81
—	—	30	30	3	—	50	26HP92BM*81	26HP92WM*81	26HP92FM*81	26HP92HM*81	26HP92NM*81
25	30	50	50	3	—	125	26HP92BN*81	26HP92WN*81	26HP92FN*81	26HP92HN*81	26HP92NN*81
30	40	75	75	—	3 1/2	125	26IP92BP*81	26IP92WP*81	26IP92FP*81	26IP92HP*81	26IP92NP*81
40	50	100	100	4	—	150	26JP92BR*81	26JP92WR*81	26JP92FR*81	26JP92HR*81	26JP92NR*81

Note: All starter sizes carry one maximum Hp rating (per the National Electric Code).

ⓐ Dual voltage coils not available in starter sizes 5–8.

ⓑ For conduit hubs and conversion instructions, see page 9/110.

ⓒ Enclosure is NEMA Type 4 (painted steel).

ⓓ F coil 100–250V AC 50/60Hz, or DC, H coil 150–500V AC 50/60Hz, or DC

ⓔ Only available

F coil 100–250V AC 50/60Hz, or DC

Features and Benefits

General

Features

- Rugged Industrial Design
- Dual Voltage, Dual Frequency Coils
- Compact Design
- Snap-On Front Removable Auxiliary Contacts
- Electrical and Mechanical Interlocks
- Half Sizes — Space and Cost Savings
- Industrial Type Disconnect Operating Handle
- Visible Blade Disconnect Thru Size 4
- Adjustable Motor Circuit Protector
- 100,000 Amp Fault Protection with MCP or Class R Fuses
- Pilot Device Locations identified on All Enclosures
- UL Listed File #E14900
- CSA Certified File #LR6535

Applications

Multi-speed magnetic starters automatically reconnect multi-speed motor windings for the desired speed in response to a signal received from push button stations or other pilot devices.

These starters are available for two speed motors.

Consequent Pole multi-speed motors having two speeds on a single winding (consequent pole) require a starter which reconnects the motor leads to half the number of effective motor poles at the high speed point. In this type of motor, **the low speed is one half the high speed.**

Separate Windings motors having separate windings for each speed provide more varied speed combinations in that the low speed need not be one half the high speed.

Starters for separate winding motors consist of a starter unit for each speed.

Multi-speed motor starters are available for constant torque, variable torque and constant horsepower motors.

Constant Torque motors maintain constant torque at all speeds. Horsepower varies directly with speed. This type of motor is applicable to conveyors, mills and similar applications.

Variable Torque motors produce a torque characteristic which varies as the square of the speed. This type of

motor is applicable to fans, blowers and centrifugal pumps.

Constant Horsepower motors maintain constant horsepower at all speeds and therefore torque varies inversely with speed. This type of motor is applicable where the same horsepower is required at all speeds. **The higher current required at low speed requires derating on starters for constant horsepower applications.** This type of motor is applicable to metal working machines such as drills, lathes, mills, bending machines, punch presses, and power wrenches.

Operation

Magnetic starters for multi-speed applications select the desired speed in accordance with the pilot control.

The shock to machinery upon the reduction of speed is greater than when the speed is increased. Therefore, the pilot control should be wired so that the stop button must be depressed before dropping to a lower speed or time delays should be used for applications requiring full automatic operations. The multi-speed controls are available with the necessary interlocks or relays to provide this type of operation.

These controls may be modified for compelling or acceleration pilot control.

Selective Control permits the operator to start the motor at any speed and to change to a higher speed by merely pushing a button. To change to a lower speed it is necessary to first depress the stop button and to then press the proper speed button. Selective control is a function of the pilot control selected and requires no starter modifications.

Compelling Control requires that the motor always be started at the lower speed and that the push buttons be operated in speed sequence to go to the next higher speed. To change to a lower speed, the stop button must be depressed and then the push buttons operated in speed sequence until the desired speed is reached. Compelling control can be added from the factory modification section page 9/122.

Acceleration Control provides that the motor be accelerated automatically with timers by progressively energizing the controls from the push button station from the lowest to highest speed. To change to a lower speed the stop button is depressed and then it is necessary to proceed as if starting from rest. Acceleration control can be added from the factory modification section page 9/122.

Deceleration Control provides that the motor be decelerated automatically with a timer when going from high speed to low speed. The timer allows the motor to decelerate from high speed to a lower speed before automatically restarting the motor in low speed. Deceleration control can be added from the factory modification section page 9/122.

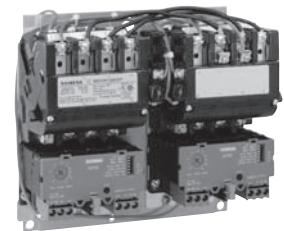

Open Style Two Speed Starter
(ESP100 Overload)

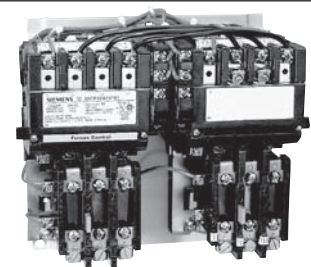

Open Style Two Speed Starter
(Ambient Compensated Overload)

Constant or Variable Torque with Solid State Overload, Class 30

Selection

<p>2S2W Starter (ESP200 Overload)</p>	<p>Ordering Information</p> <p>Replace the (*) with a letter from the coil table. Dual voltage coils are wired on high voltage unless specified on order.</p> <p>Replace the (†) with the letter that corresponds to the correct low speed FLA in the FLA table.®</p> <p>Field Modification Kits see page 9/104.</p> <p>Factory Modifications see page 9/119.</p> <p>Dimensions see page 9/150.</p> <p>Wiring Diagrams see page 9/178.</p> <p>Replacement Parts see page 9/131.</p>	<p>Coil Table</p> <table border="1"> <thead> <tr> <th>60Hz Voltage</th> <th>Letter</th> </tr> </thead> <tbody> <tr><td>24</td><td>J</td></tr> <tr><td>120</td><td>F</td></tr> <tr><td>110–120/220–240</td><td>A</td></tr> <tr><td>200–208</td><td>D</td></tr> <tr><td>220–240</td><td>G</td></tr> <tr><td>277</td><td>L</td></tr> <tr><td>220–240/440–480</td><td>C</td></tr> <tr><td>440–480</td><td>H</td></tr> <tr><td>575–600</td><td>E</td></tr> </tbody> </table> <p>For other voltages and frequencies, see Factory Modifications page 9/119.</p>	60Hz Voltage	Letter	24	J	120	F	110–120/220–240	A	200–208	D	220–240	G	277	L	220–240/440–480	C	440–480	H	575–600	E	<p>Low Speed FLA Table</p> <table border="1"> <thead> <tr> <th>Size</th> <th>FLA</th> <th>OLR Frame Size</th> <th>†</th> </tr> </thead> <tbody> <tr><td>0,1</td><td>0.25–1</td><td>A</td><td>A</td></tr> <tr><td>0,1</td><td>0.75–3.4</td><td>A</td><td>B</td></tr> <tr><td>0,1</td><td>3–12</td><td>A1</td><td>C</td></tr> <tr><td>0,1</td><td>5.5–22</td><td>A1</td><td>D</td></tr> <tr><td>0-1³/₄</td><td>10–40</td><td>A1</td><td>E</td></tr> <tr><td>2-3</td><td>13–52</td><td>B</td><td>F</td></tr> <tr><td>2-3</td><td>25–100</td><td>B</td><td>G</td></tr> <tr><td>3¹/₂-4</td><td>50–200</td><td>B</td><td>H</td></tr> </tbody> </table>	Size	FLA	OLR Frame Size	†	0,1	0.25–1	A	A	0,1	0.75–3.4	A	B	0,1	3–12	A1	C	0,1	5.5–22	A1	D	0-1 ³ / ₄	10–40	A1	E	2-3	13–52	B	F	2-3	25–100	B	G	3 ¹ / ₂ -4	50–200	B	H
	60Hz Voltage	Letter																																																									
24	J																																																										
120	F																																																										
110–120/220–240	A																																																										
200–208	D																																																										
220–240	G																																																										
277	L																																																										
220–240/440–480	C																																																										
440–480	H																																																										
575–600	E																																																										
Size	FLA	OLR Frame Size	†																																																								
0,1	0.25–1	A	A																																																								
0,1	0.75–3.4	A	B																																																								
0,1	3–12	A1	C																																																								
0,1	5.5–22	A1	D																																																								
0-1 ³ / ₄	10–40	A1	E																																																								
2-3	13–52	B	F																																																								
2-3	25–100	B	G																																																								
3 ¹ / ₂ -4	50–200	B	H																																																								

One Winding Consequent Pole, 3-Phase (Constant or Variable Torque)

Max Hp				NEMA Size	Half Size	Amp Range	Frame Size	Enclosure		NEMA 1 General Purpose	NEMA 4/4X Stainless [Ⓞ] Watertight, Dust-tight, Corrosion Resistant 304 Stainless Steel	NEMA 4X Fiberglass Watertight, Dust-tight Corrosion Resistant	NEMA 12 NEMA 3/3R [Ⓞ] Industrial Use Weatherproof (Field Convertible to 3/3R)				
200 Volts	230 Volts	460 Volts	575 Volts					Open Type [Ⓞ] Standard Auxiliary Contacts [Ⓞ]	List Price \$					Catalog Number	List Price \$	Catalog Number	List Price \$
1/2	3/4	1 1/2	2	0	—	0.75–3.4	A	30CUB†32A2V*		30CUB†32B2V*		30CUB†32W2V*		30CUB†32F2V*		30CUB†32O2V*	
2	2	5	5	0	—	3–12	A1	30CUC†32A2V*		30CUC†32B2V*		30CUC†32W2V*		30CUC†32F2V*		30CUC†32O2V*	
3	3	—	—	0	—	5.5–22	A1	30CUD†32A2V*		30CUD†32B2V*		30CUD†32W2V*		30CUD†32F2V*		30CUD†32O2V*	
1/2	3/4	1 1/2	1 1/2	1	—	0.75–3.4	A	30DUB†32A2V*		30DUB†32B2V*		30DUB†32W2V*		30DUB†32F2V*		30DUB†32O2V*	
2	2	5	5	1	—	3–12	A1	30DUC†32A2V*		30DUC†32B2V*		30DUC†32W2V*		30DUC†32F2V*		30DUC†32O2V*	
3	3	10	10	1	—	5.5–22	A1	30DUD†32A2V*		30DUD†32B2V*		30DUD†32W2V*		30DUD†32F2V*		30DUD†32O2V*	
7 1/2	7 1/2	—	—	1	—	10–40	A1	30DUE†32A2V*		30DUE†32B2V*		30DUE†32W2V*		30DUE†32F2V*		30DUE†32O2V*	
10	10	15	15	—	1 1/2	10–40	A1	30EUE†32A2V*		30EUE†32B2V*		30EUE†32W2V*		30EUE†32F2V*		30EUE†32O2V*	
10	15	25	25	2	—	13–52	B	30FUF†32A2V*		30FUF†32B2V*		30FUF†32W2V*		30FUF†32F2V*		30FUF†32O2V*	
15	20	30	30	—	2 1/2	25–100	B	30GUG†32A2V*		30GUG†32B2V*		30GUG†32W2V*		30GUG†32F2V*		30GUG†32O2V*	
25	30	50	50	3	—	25–100	B	30HUG†32A2V*		30HUG†32B2V*		30HUG†32W2V*		30HUG†32F2V*		30HUG†32O2V*	
30	40	75	75	—	3 1/2	50–200	B	30IUH†32A2V*		30IUH†32B2V*		30IUH†32W2V*		30IUH†32F2V*		30IUH†32O2V*	
40	50	100	100	4	—	50–200	B	30JUH†32A2V*		30JUH†32B2V*		30JUH†32W2V*		30JUH†32F2V*		30JUH†32O2V*	

Two Separate Windings, 3-Phase (Constant or Variable Torque)

Max Hp				NEMA Size	Half Size	Amp Range	Frame Size	Enclosure		NEMA 1 General Purpose	NEMA 4/4X Stainless [Ⓞ] Watertight, Dust-tight, Corrosion Resistant 304 Stainless Steel 316 Stainless Steel (Optional)	NEMA 4X Fiberglass Watertight, Dust-tight Corrosion Resistant	NEMA 12 NEMA 3/3R [Ⓞ] Industrial Use Weatherproof (Field Convertible to 3/3R)				
200 Volts	230 Volts	460 Volts	575 Volts					Open Type [Ⓞ] Standard Auxiliary Contacts	List Price \$					Catalog Number	List Price \$	Catalog Number	List Price \$
1/2	3/4	1 1/2	2	0	—	0.75–3.4	A	30CUB†32A1V*		30CUB†32B1V*		30CUB†32W1V*		30CUB†32F1V*		30CUB†32O1V*	
2	2	5	5	0	—	3–12	A1	30CUC†32A1V*		30CUC†32B1V*		30CUC†32W1V*		30CUC†32F1V*		30CUC†32O1V*	
3	3	—	—	0	—	5.5–22	A1	30CUD†32A1V*		30CUD†32B1V*		30CUD†32W1V*		30CUD†32F1V*		30CUD†32O1V*	
1/2	3/4	1 1/2	1 1/2	1	—	0.75–3.4	A	30DUB†32A1V*		30DUB†32B1V*		30DUB†32W1V*		30DUB†32F1V*		30DUB†32O1V*	
2	2	5	5	1	—	3–12	A1	30DUC†32A1V*		30DUC†32B1V*		30DUC†32W1V*		30DUC†32F1V*		30DUC†32O1V*	
3	3	10	10	1	—	5.5–22	A1	30DUD†32A1V*		30DUD†32B1V*		30DUD†32W1V*		30DUD†32F1V*		30DUD†32O1V*	
7 1/2	7 1/2	—	—	1	—	10–40	A1	30DUE†32A1V*		30DUE†32B1V*		30DUE†32W1V*		30DUE†32F1V*		30DUE†32O1V*	
10	10	15	15	—	1 1/2	10–40	A1	30EUE†32A1V*		30EUE†32B1V*		30EUE†32W1V*		30EUE†32F1V*		30EUE†32O1V*	
10	15	25	25	2	—	13–52	B	30FUF†32A1V*		30FUF†32B1V*		30FUF†32W1V*		30FUF†32F1V*		30FUF†32O1V*	
15	20	30	30	—	2 1/2	25–100	B	30GUG†32A1V*		30GUG†32B1V*		30GUG†32W1V*		30GUG†32F1V*		30GUG†32O1V*	
25	30	50	50	3	—	25–100	B	30HUG†32A1V*		30HUG†32B1V*		30HUG†32W1V*		30HUG†32F1V*		30HUG†32O1V*	
30	40	75	75	—	3 1/2	50–200	B	30IUH†32A1V*		30IUH†32B1V*		30IUH†32W1V*		30IUH†32F1V*		30IUH†32O1V*	
40	50	100	100	4	—	50–200	B	30JUH†32A1V*		30JUH†32B1V*		30JUH†32W1V*		30JUH†32F1V*		30JUH†32O1V*	

Note: All starter sizes carry one maximum Hp rating (per the National Electric Code).

Ⓞ For conduit hubs and conversion instructions, see page 9/110.

Ⓞ If motor FLA are unknown, select overload on the basis that low speed FLA will be no greater than 50% of high speed FLA.

Ⓞ Auxiliary contacts 30C-30E 4th pole built-in 30F-30J 2 NO & 2 NC

Constant HP with Solid State Overload, Class 30

Selection

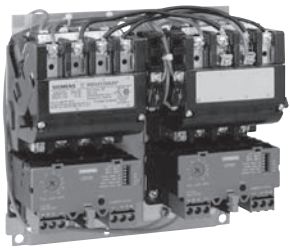
 <p>2S2W Starter (ESP200 Overload)</p>	<p>Ordering Information</p> <p>Replace the (*) with a letter from the coil table. Dual voltage coils are wired on high voltage unless specified on order.</p> <p>Replace the (t) with the letter that corresponds to the correct FLA in High/Low Speed FLA Table.[®]</p> <p>Field Modification Kits see page 9/104.</p> <p>Factory Modifications see page 9/119.</p> <p>Dimensions see page 9/150.</p> <p>Wiring Diagrams see page 9/178.</p> <p>Replacement Parts see page 9/131.</p>	<p>Coil Table</p> <table border="1"> <thead> <tr> <th>60Hz Voltage</th> <th>Letter</th> </tr> </thead> <tbody> <tr><td>24</td><td>J</td></tr> <tr><td>120</td><td>F</td></tr> <tr><td>110–120/220–240</td><td>A</td></tr> <tr><td>200–208</td><td>D</td></tr> <tr><td>220–240</td><td>G</td></tr> <tr><td>277</td><td>L</td></tr> <tr><td>220–240/440–480</td><td>C</td></tr> <tr><td>440–480</td><td>H</td></tr> <tr><td>575–600</td><td>E</td></tr> </tbody> </table> <p>For other voltages and frequencies, see Factory Modifications page 9/119.</p>	60Hz Voltage	Letter	24	J	120	F	110–120/220–240	A	200–208	D	220–240	G	277	L	220–240/440–480	C	440–480	H	575–600	E	<p>High/Low Speed FLA Table[®]</p> <table border="1"> <thead> <tr> <th>Size</th> <th>FLA</th> <th>OLR Frame Size</th> <th>t</th> </tr> </thead> <tbody> <tr><td>0,1</td><td>0.25–1</td><td>A</td><td>A</td></tr> <tr><td>0,1</td><td>0.75–3.4</td><td>A</td><td>B</td></tr> <tr><td>0,1</td><td>3–12</td><td>A1</td><td>C</td></tr> <tr><td>0,1</td><td>5.5–22</td><td>A1</td><td>D</td></tr> <tr><td>0-1³/₄</td><td>10–40</td><td>A1</td><td>E</td></tr> <tr><td>2-3</td><td>13–52</td><td>B</td><td>F</td></tr> <tr><td>2-3</td><td>25–100</td><td>B</td><td>G</td></tr> <tr><td>3¹/₂-4</td><td>50–200</td><td>B</td><td>H</td></tr> </tbody> </table> <p>* First (t) for high speed, second (t) for low speed. Use motor nameplate to select FLA. If motor FLA are unknown, select overload on the bases that the low speed FLA will be no greater than 50 % of high speed FLA.</p>	Size	FLA	OLR Frame Size	t	0,1	0.25–1	A	A	0,1	0.75–3.4	A	B	0,1	3–12	A1	C	0,1	5.5–22	A1	D	0-1 ³ / ₄	10–40	A1	E	2-3	13–52	B	F	2-3	25–100	B	G	3 ¹ / ₂ -4	50–200	B	H
	60Hz Voltage	Letter																																																									
24	J																																																										
120	F																																																										
110–120/220–240	A																																																										
200–208	D																																																										
220–240	G																																																										
277	L																																																										
220–240/440–480	C																																																										
440–480	H																																																										
575–600	E																																																										
Size	FLA	OLR Frame Size	t																																																								
0,1	0.25–1	A	A																																																								
0,1	0.75–3.4	A	B																																																								
0,1	3–12	A1	C																																																								
0,1	5.5–22	A1	D																																																								
0-1 ³ / ₄	10–40	A1	E																																																								
2-3	13–52	B	F																																																								
2-3	25–100	B	G																																																								
3 ¹ / ₂ -4	50–200	B	H																																																								

One Winding Consequent Pole, 3-Phase (Constant Horsepower)

Max Hp							Enclosure									
200 Volts	230 Volts	460 Volts	575 Volts	NEMA Size	Half Size		Open Type Standard Auxiliary Contacts ^③		NEMA 1 General Purpose		NEMA 4/4X Stainless ^① Watertight, Dust-tight, Corrosion Resistant 304 Stainless Steel		NEMA 4X Fiberglass Watertight, Dust-tight Corrosion Resistant		NEMA 12 NEMA 3/3R ^② Industrial Use Weatherproof (Field Convertible to 3/3R)	
Catalog Number	List Price \$	Catalog Number	List Price \$	Catalog Number	List Price \$	Catalog Number	List Price \$	Catalog Number	List Price \$	Catalog Number	List Price \$	Catalog Number	List Price \$	Catalog Number	List Price \$	
2	2	3	3	0	—	30CU††32A2H*		30CU††32B2H*		30CU††32W2H*		30CU††32F2H*		30CU††32O2H*		
5	5	7½	7½	1	—	30DU††32A2H*		30DU††32B2H*		30DU††32W2H*		30DU††32F2H*		30DU††32O2H*		
7½	7½	10	10	—	1½	30EU††32A2H*		30EU††32B2H*		30EU††32W2H*		30EU††32F2H*		30EU††32O2H*		
7½	10	20	20	2	—	30FU††32A2H*		30FU††32B2H*		30FU††32W2H*		30FU††32F2H*		30FU††32O2H*		
10	15	25	25	—	2½	30GU††32A2H*		30GU††32B2H*		30GU††32W2H*		30GU††32F2H*		30GU††32O2H*		
20	25	40	40	3	—	30HU††32A2H*		30HU††32B2H*		30HU††32W2H*		30HU††32F2H*		30HU††32O2H*		
25	30	50	50	—	3½	30IU††32A2H*		30IU††32B2H*		30IU††32W2H*		30IU††32F2H*		30IU††32O2H*		
30	40	75	75	4	—	30JU††32A2H*		30JU††32B2H*		30JU††32W2H*		30JU††32F2H*		30JU††32O2H*		

Two Separate Windings, 3-Phase (Constant Horsepower)

Max Hp							Enclosure									
200 Volts	230 Volts	460 Volts	575 Volts	NEMA Size	Half Size		Open Type Standard Auxiliary Contacts ^③		NEMA 1 General Purpose		NEMA 4/4X Stainless ^① Watertight, Dust-tight, Corrosion Resistant 304 Stainless Steel		NEMA 4X Fiberglass Watertight, Dust-tight Corrosion Resistant		NEMA 12 NEMA 3/3R ^② Industrial Use Weatherproof (Field Convertible to 3/3R)	
Catalog Number	List Price \$	Catalog Number	List Price \$	Catalog Number	List Price \$	Catalog Number	List Price \$	Catalog Number	List Price \$	Catalog Number	List Price \$	Catalog Number	List Price \$	Catalog Number	List Price \$	
2	2	3	3	0	—	30CU††32A1H*		30CU††32B1H*		30CU††32W1H*		30CU††32F1H*		30CU††32O1H*		
5	5	7½	7½	1	—	30DU††32A1H*		30DU††32B1H*		30DU††32W1H*		30DU††32F1H*		30DU††32O1H*		
7½	7½	10	10	—	1¾	30EU††32A1H*		30EU††32B1H*		30EU††32W1H*		30EU††32F1H*		30EU††32O1H*		
7½	10	20	20	2	—	30FU††32A1H*		30FU††32B1H*		30FU††32W1H*		30FU††32F1H*		30FU††32O1H*		
10	15	25	25	—	2½	30GU††32A1H*		30GU††32B1H*		30GU††32W1H*		30GU††32F1H*		30GU††32O1H*		
20	25	40	40	3	—	30HU††32A1H*		30HU††32B1H*		30HU††32W1H*		30HU††32F1H*		30HU††32O1H*		
25	30	50	50	—	3½	30IU††32A1H*		30IU††32B1H*		30IU††32W1H*		30IU††32F1H*		30IU††32O1H*		
30	40	75	75	4	—	30JU††32A1H*		30JU††32B1H*		30JU††32W1H*		30JU††32F1H*		30JU††32O1H*		

Note: All starter sizes carry one maximum Hp rating (per the National Electric Code).

① For conduit hubs and conversion instructions, see page 9/110.

② First (t) for high speed, second (t) for low speed. Use motor nameplate information to select FLA. If motor FLA are unknown, select overload on the basis that low speed FLA will be no greater than 50% of high speed FLA.

③ Auxiliary contacts
30C-30E 4th pole built-in
30F-30J 2 NO & 2 NC

Selection

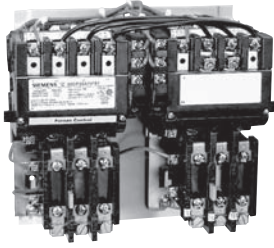
 <p>2S2W starter (Amb. Comp. Bimetal OL)</p>	<p>Ordering Information</p> <p>Replace the (*) with a letter from the coil table. Dual voltage coils are wired on high voltage unless specified on order.</p> <p>Heater elements see page 9/124 (6 required)^②</p> <p>Field Modification Kits see page 9/104.</p> <p>Factory Modifications see page 9/119.</p> <p>Dimensions see pages 9/143 open and 9/150 enclosed.</p> <p>Wiring Diagrams see page 9/178.</p> <p>Replacement Parts see page 9/131.</p> <p>For NO/NC SPDT contact on overload relay, replace "81" with "91". "81" indicates one NC contact.</p>	<p>Coil Table</p> <table border="1"> <thead> <tr> <th>60Hz Voltage</th> <th>Letter</th> </tr> </thead> <tbody> <tr><td>24</td><td>J</td></tr> <tr><td>120</td><td>F</td></tr> <tr><td>110–120/220–240</td><td>A</td></tr> <tr><td>200–208</td><td>D</td></tr> <tr><td>220–240</td><td>G</td></tr> <tr><td>277</td><td>L</td></tr> <tr><td>220–240/440–480</td><td>C</td></tr> <tr><td>440–480</td><td>H</td></tr> <tr><td>575–600</td><td>E</td></tr> </tbody> </table> <p>For other voltages and frequencies, see Factory Modifications page 9/119.</p>	60Hz Voltage	Letter	24	J	120	F	110–120/220–240	A	200–208	D	220–240	G	277	L	220–240/440–480	C	440–480	H	575–600	E
	60Hz Voltage	Letter																				
24	J																					
120	F																					
110–120/220–240	A																					
200–208	D																					
220–240	G																					
277	L																					
220–240/440–480	C																					
440–480	H																					
575–600	E																					

One Winding Consequent Pole, 3 Phase (Constant or Variable Torque)

Max Hp					Contact Amp Rating	NEMA Size	Half Size	Enclosure									
200 Volts	230 Volts	460 Volts	575 Volts	Open Type ^③				NEMA 1 General Purpose		NEMA 4/4X Stainless ^① Watertight, Dust-tight Corrosion Resistant 304 Stainless Steel		NEMA 4X Fiberglass Watertight, Dust-tight Corrosion Resistant		NEMA 12 ^④ NEMA 3/3R Industrial Use Weatherproof			
				Catalog Number				List Price \$	Catalog Number	List Price \$	Catalog Number	List Price \$	Catalog Number	List Price \$	Catalog Number	List Price \$	
3	3	5	5	18	0	—	30CP32A2V*81		30CP32B2V*81		30CP32W2V*81		30CP32F2V*81		30CP32O2V*81		
7½	7½	10	10	27	1	—	30DP32A2V*81		30DP32B2V*81		30DP32W2V*81		30DP32F2V*81		30DP32O2V*81		
10	10	15	15	40	—	1¾	30EP32A2V*81		30EP32B2V*81		30EP32W2V*81		30EP32F2V*81		30EP32O2V*81		
10	15	25	25	45	2	—	30FP32A2V*81		30FP32B2V*81		30FP32W2V*81		30FP32F2V*81		30FP32O2V*81		
15	20	30	30	60	—	2½	30GP32A2V*81		30GP32B2V*81		30GP32W2V*81		30GP32F2V*81		30GP32O2V*81		
25	30	50	50	90	3	—	30HP32A2V*81		30HP32B2V*81		30HP32W2V*81		30HP32F2V*81		30HP32O2V*81		
30	40	75	75	115	—	3½	30IP32A2V*81		30IP32B2V*81		30IP32W2V*81		30IP32F2V*81		30IP32O2V*81		
40	50	100	100	135	4	—	30JG32A2V*81		30JG32B2V*81		30JG32W2V*81		30JG32F2V*81		30JG32O2V*81		

Two Separate Windings, 3-Phase (Constant or Variable Torque)

Max Hp					Contact Amp Rating	NEMA Size	Half Size	Enclosure									
200 Volts	230 Volts	460 Volts	575 Volts	Open Type ^③				NEMA 1 General Purpose		NEMA 4/4X Stainless ^① Watertight, Dust-tight Corrosion Resistant 304 Stainless Steel		NEMA 4X Fiberglass Watertight, Dust-tight Corrosion Resistant		NEMA 12 ^④ NEMA 3/3R Industrial Use Weatherproof			
				Catalog Number				List Price \$	Catalog Number	List Price \$	Catalog Number	List Price \$	Catalog Number	List Price \$	Catalog Number	List Price \$	
3	3	5	5	18	0	—	30CP32A1V*81		30CP32B1V*81		30CP32W1V*81		30CP32F1V*81		30CP32O1V*81		
7½	7½	10	10	27	1	—	30DP32A1V*81		30DP32B1V*81		30DP32W1V*81		30DP32F1V*81		30DP32O1V*81		
10	10	15	15	40	—	1¾	30EP32A1V*81		30EP32B1V*81		30EP32W1V*81		30EP32F1V*81		30EP32O1V*81		
10	15	25	25	45	2	—	30FP32A1V*81		30FP32B1V*81		30FP32W1V*81		30FP32F1V*81		30FP32O1V*81		
15	20	30	30	60	—	2½	30GP32A1V*81		30GP32B1V*81		30GP32W1V*81		30GP32F1V*81		30GP32O1V*81		
25	30	50	50	90	3	—	30HP32A1V*81		30HP32B1V*81		30HP32W1V*81		30HP32F1V*81		30HP32O1V*81		
30	40	75	75	115	—	3½	30IP32A1V*81		30IP32B1V*81		30IP32W1V*81		30IP32F1V*81		30IP32O1V*81		
40	50	100	100	135	4	—	30JG32A1V*81		30JG32B1V*81		30JG32W1V*81		30JG32F1V*81		30JG32O1V*81		

Note: Hp's shown above are based on the overload amp range for the FLA's (per the National Electric Code) of typical industrial motors. All starter sizes carry one maximum Hp rating.

① For conduit hubs and conversion instructions, see page 9/110.

② If motor FLA are unknown, select heater elements on the basis that low speed FLA will be no greater than 50% of high speed FLA.

③ Auxiliary contacts
30C-30E 4th pole built-in
30F-30J 2 NO & 2 NC

Constant HP with Ambient Compensated Bimetal Overload, Class 30

Selection

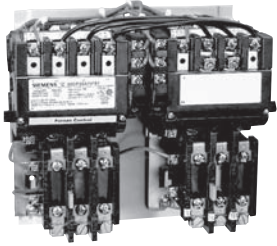
 <p>2S2W starter (Amb. Comp. Bimetal OL)</p>	Ordering Information	Coil Table																			
	<p>Replace the (*) with a letter from the coil table. Dual voltage coils are wired on high voltage unless specified on order.</p> <p>Heater elements see page 9/124 (6 required)²</p> <p>Field Modification Kits see page 9/104.</p> <p>Factory Modifications see page 9/119.</p> <p>Dimensions see pages 9/143 open and 9/150 enclosed.</p> <p>Wiring Diagrams see page 9/178.</p> <p>Replacement Parts see page 9/131.</p> <p>For NO/NC SPDT contact on overload relay, replace "81" with "91". "81" indicates one NC contact.</p>	<table border="1"> <thead> <tr> <th>60Hz Voltage</th> <th>Letter</th> </tr> </thead> <tbody> <tr><td>24</td><td>J</td></tr> <tr><td>120</td><td>F</td></tr> <tr><td>110–120/220–240</td><td>A</td></tr> <tr><td>200–208</td><td>D</td></tr> <tr><td>220–240</td><td>G</td></tr> <tr><td>277</td><td>L</td></tr> <tr><td>220–240/440–480</td><td>C</td></tr> <tr><td>440–480</td><td>H</td></tr> <tr><td>575–600</td><td>E</td></tr> </tbody> </table> <p>For other voltages and frequencies, see Factory Modifications page 9/119.</p>	60Hz Voltage	Letter	24	J	120	F	110–120/220–240	A	200–208	D	220–240	G	277	L	220–240/440–480	C	440–480	H	575–600
60Hz Voltage	Letter																				
24	J																				
120	F																				
110–120/220–240	A																				
200–208	D																				
220–240	G																				
277	L																				
220–240/440–480	C																				
440–480	H																				
575–600	E																				

One Winding Consequent Pole, 3-Phase (Constant Horsepower)

Max Hp								Enclosure									
200 Volts	230 Volts	460 Volts	575 Volts	Cont-actor Amp Rating	NEMA Size	Half Size		Open Type ³		NEMA 1 General Purpose		NEMA 4/4X Stainless ¹ Watertight, Dust-tight Corrosion Resistant 304 Stainless Steel		NEMA 4X Fiberglass Watertight, Dust-tight Corrosion Resistant		NEMA 12 ¹ NEMA 3/3R Industrial Use Weatherproof	
								Catalog Number	List Price \$	Catalog Number	List Price \$	Catalog Number	List Price \$	Catalog Number	List Price \$	Catalog Number	List Price \$
2	2	3	3	18	0	—		30CP32A2H*81		30CP32B2H*81		30CP32W2H*81		30CP32F2H*81		30CP3202H*81	
5	5	7½	7½	27	1	—		30DP32A2H*81		30DP32B2H*81		30DP32W2H*81		30DP32F2H*81		30DP3202H*81	
7½	7½	10	10	40	—	1¼		30EP32A2H*81		30EP32B2H*81		30EP32W2H*81		30EP32F2H*81		30EP3202H*81	
7½	10	20	20	45	2	—		30FP32A2H*81		30FP32B2H*81		30FP32W2H*81		30FP32F2H*81		30FP3202H*81	
10	15	25	25	60	—	2½		30GP32A2H*81		30GP32B2H*81		30GP32W2H*81		30GP32F2H*81		30GP3202H*81	
20	25	40	40	90	3	—		30HP32A2H*81		30HP32B2H*81		30HP32W2H*81		30HP32F2H*81		30HP3202H*81	
25	30	50	50	115	—	3½		30IP32A2H*81		30IP32B2H*81		30IP32W2H*81		30IP32F2H*81		30IP3202H*81	
30	40	75	75	135	4	—		30JG32A2H*81		30JG32B2H*81		30JG32W2H*81		30JG32F2H*81		30JG3202H*81	

Two Separate Windings, 3-Phase (Constant Horsepower)

Max Hp								Enclosure									
200 Volts	230 Volts	460 Volts	575 Volts	Cont-actor Amp Rating	NEMA Size	Half Size		Open Type ³		NEMA 1 General Purpose		NEMA 4/4X Stainless ¹ Watertight, Dust-tight Corrosion Resistant 304 Stainless Steel		NEMA 4X Fiberglass Watertight, Dust-tight Corrosion Resistant		NEMA 12 ¹ NEMA 3/3R Industrial Use Weatherproof	
								Catalog Number	List Price \$	Catalog Number	List Price \$	Catalog Number	List Price \$	Catalog Number	List Price \$	Catalog Number	List Price \$
2	2	3	3	18	0	—		30CP32A1H*81		30CP32B1H*81		30CP32W1H*81		30CP32F1H*81		30CP3201H*81	
5	5	7½	7½	27	1	—		30DP32A1H*81		30DP32B1H*81		30DP32W1H*81		30DP32F1H*81		30DP3201H*81	
7½	7½	10	10	40	—	1¼		30EP32A1H*81		30EP32B1H*81		30EP32W1H*81		30EP32F1H*81		30EP3201H*81	
7½	10	20	20	45	2	—		30FP32A1H*81		30FP32B1H*81		30FP32W1H*81		30FP32F1H*81		30FP3201H*81	
10	15	25	25	60	—	2½		30GP32A1H*81		30GP32B1H*81		30GP32W1H*81		30GP32F1H*81		30GP3201H*81	
20	25	40	40	90	3	—		30HP32A1H*81		30HP32B1H*81		30HP32W1H*81		30HP32F1H*81		30HP3201H*81	
25	30	50	50	115	—	3½		30IP32A1H*81		30IP32B1H*81		30IP32W1H*81		30IP32F1H*81		30IP3201H*81	
30	40	75	75	135	4	—		30JG32A1H*81		30JG32B1H*81		30JG32W1H*81		30JG32F1H*81		30JG3201H*81	

Note: Hp's shown above are based on the overload amp range for the FLA's (per the National Electric Code) of typical industrial motors. All starter sizes carry one maximum Hp rating.

¹ For conduit hubs and conversion instructions, see page 9/110.

² If motor FLA are unknown, select heater element on the basis that low speed FLA will be no greater than 50% of high speed FLA.

³ Auxiliary contacts
30C-30E 4th pole built-in
30F-30J 2 NO & 2 NC

Non-Fusible, Constant or Variable Torque with Solid State Overload, Class 32

Selection

	<p>Ordering Information</p> <p>Replace the (*) with a letter from the coil table. Dual voltage coils are wired on high voltage unless specified on order.</p> <p>Replace the (†) with the letter that corresponds to the correct low speed FLA in the FLA table.^③</p> <p>Fuse clips see page 9/120.</p> <p>Field Modification Kits see page 9/104.</p> <p>Factory Modifications see page 9/119.</p> <p>Dimensions see page 9/178.</p> <p>Wiring Diagrams see page 9/178.</p> <p>Replacement Parts see page 9/131.</p>	<p>Coil Table</p>		<p>Low Speed FLA Table</p>																																																												
		<table border="1"> <thead> <tr> <th>60Hz Voltage</th> <th>Letter</th> <th>Size</th> <th>FLA</th> <th>OLR Frame Size</th> <th>†</th> </tr> </thead> <tbody> <tr><td>24</td><td>J</td><td>0,1</td><td>0.25-1</td><td>A</td><td>A</td></tr> <tr><td>120</td><td>F</td><td>0,1</td><td>0.75-3.4</td><td>A</td><td>B</td></tr> <tr><td>110-120/220-240^①</td><td>A</td><td>0,1</td><td>3-12</td><td>A1</td><td>C</td></tr> <tr><td>200-208</td><td>D</td><td>0,1</td><td>5.5-22</td><td>A1</td><td>D</td></tr> <tr><td>220-240</td><td>G</td><td>0-1^{3/4}</td><td>10-40</td><td>A1</td><td>E</td></tr> <tr><td>277</td><td>L</td><td>2-3</td><td>13-52</td><td>B</td><td>F</td></tr> <tr><td>220-240/440-480^②</td><td>C</td><td>2-3</td><td>25-100</td><td>B</td><td>G</td></tr> <tr><td>440-480</td><td>H</td><td>3^{1/2}-4</td><td>50-200</td><td>B</td><td>H</td></tr> <tr><td>575-600</td><td>E</td><td></td><td></td><td></td><td></td></tr> </tbody> </table>	60Hz Voltage	Letter	Size	FLA	OLR Frame Size	†	24	J	0,1	0.25-1	A	A	120	F	0,1	0.75-3.4	A	B	110-120/220-240 ^①	A	0,1	3-12	A1	C	200-208	D	0,1	5.5-22	A1	D	220-240	G	0-1 ^{3/4}	10-40	A1	E	277	L	2-3	13-52	B	F	220-240/440-480 ^②	C	2-3	25-100	B	G	440-480	H	3 ^{1/2} -4	50-200	B	H	575-600	E					<p>For other voltages and frequencies, see Factory Modifications page 9/119.</p>	
60Hz Voltage	Letter	Size	FLA	OLR Frame Size	†																																																											
24	J	0,1	0.25-1	A	A																																																											
120	F	0,1	0.75-3.4	A	B																																																											
110-120/220-240 ^①	A	0,1	3-12	A1	C																																																											
200-208	D	0,1	5.5-22	A1	D																																																											
220-240	G	0-1 ^{3/4}	10-40	A1	E																																																											
277	L	2-3	13-52	B	F																																																											
220-240/440-480 ^②	C	2-3	25-100	B	G																																																											
440-480	H	3 ^{1/2} -4	50-200	B	H																																																											
575-600	E																																																															

One Winding Consequent Pole, 3-Phase (Constant or Variable Torque)

Max Hp				NEMA Size	Half Size	Overload		Disc. Amp Range	Enclosure						
200 Volts	230 Volts	460 Volts	575 Volts			Amp Range	Frame Size		NEMA 1 General Purpose	NEMA 4/4X Stainless ^② Watertight, Dust-tight, Corrosion Resistant 304 Stainless Steel	NEMA 4X Fiberglass Watertight, Dust-tight Corrosion Resistant	NEMA 12, NEMA 3/3R ^② , NEMA 4 Painted Industrial Use Weatherproof Watertight, Dust-tight			
200 Volts	230 Volts	460 Volts	575 Volts					Catalog Number	List Price \$	Catalog Number	List Price \$	Catalog Number	List Price \$	Catalog Number	List Price \$
1/2	3/4	1 1/2	2	0	—	0.75-3.4	A	30	32CUB†92B2V2*	32CUB†92W2V2*	32CUB†92F2V2*	32CUB†92N2V2*			
2	2	5	5	0	—	3-12	A1	30	32CUC†92B2V2*	32CUC†92W2V2*	32CUC†92F2V2*	32CUC†92N2V2*			
3	3	—	—	0	—	5.5-22	A1	30	32CUD†92B2V2*	32CUD†92W2V2*	32CUD†92F2V2*	32CUD†92N2V2*			
1/2	3/4	1 1/2	1 1/2	1	—	0.75-3.4	A	30	32DUB†92B2V2*	32DUB†92W2V2*	32DUB†92F2V2*	32DUB†92N2V2*			
2	2	5	5	1	—	3-12	A1	30	32DUC†92B2V2*	32DUC†92W2V2*	32DUC†92F2V2*	32DUC†92N2V2*			
3	3	10	10	1	—	5.5-22	A1	30	32DUD†92B2V2*	32DUD†92W2V2*	32DUD†92F2V2*	32DUD†92N2V2*			
7 1/2	7 1/2	—	—	1	—	10-40	A1	60	32DUE†92B2V2*	32DUE†92W2V2*	32DUE†92F2V2*	32DUE†92N2V2*			
10	10	15	15	—	1 1/2	10-40	A1	60	32EUE†92B2V2*	32EUE†92W2V2*	32EUE†92F2V2*	32EUE†92N2V2*			
10	15	25	25	2	—	13-52	B	60	32FUF†92B2V2*	32FUF†92W2V2*	32FUF†92F2V2*	32FUF†92N2V2*			
15	20	30	30	—	2 1/2	25-100	B	100	32GUG†92B2V2*	32GUG†92W2V2*	32GUG†92F2V2*	32GUG†92N2V2*			
20	25	50	50	3	—	25-100	B	100	32HUG†92B2V2*	32HUG†92W2V2*	32HUG†92F2V2*	32HUG†92N2V2*			
30	40	75	75	—	3 1/2	50-200	B	200	32IUH†92B2V2*	32IUH†92W2V2*	32IUH†92F2V2*	32IUH†92N2V2*			
40	50	100	100	4	—	50-200	B	200	32JUH†92B2V2*	32JUH†92W2V2*	32JUH†92F2V2*	32JUH†92N2V2*			

Two Separate Windings, 3-Phase (Constant or Variable Torque)

Max Hp				NEMA Size	Half Size	Overload		Disc. Amp Range	Enclosure						
200 Volts	230 Volts	460 Volts	575 Volts			Amp Range	Frame Size		NEMA 1 General Purpose	NEMA 4/4X Stainless ^② Watertight, Dust-tight, Corrosion Resistant 304 Stainless Steel	NEMA 4X Fiberglass Watertight, Dust-tight Corrosion Resistant	NEMA 12, NEMA 3/3R ^② , NEMA 4 Painted Industrial Use Weatherproof Watertight, Dust-tight			
200 Volts	230 Volts	460 Volts	575 Volts					Catalog Number	List Price \$	Catalog Number	List Price \$	Catalog Number	List Price \$	Catalog Number	List Price \$
1/2	3/4	1 1/2	2	0	—	0.75-3.4	A	30	32CUB†92B1V2*	32CUB†92W1V2*	32CUB†92F1V2*	32CUB†92N1V2*			
2	2	5	5	0	—	3-12	A1	30	32CUC†92B1V2*	32CUC†92W1V2*	32CUC†92F1V2*	32CUC†92N1V2*			
3	3	—	—	0	—	5.5-22	A1	30	32CUD†92B1V2*	32CUD†92W1V2*	32CUD†92F1V2*	32CUD†92N1V2*			
1/2	3/4	1 1/2	1 1/2	1	—	0.75-3.4	A	30	32DUB†92B1V2*	32DUB†92W1V2*	32DUB†92F1V2*	32DUB†92N1V2*			
2	2	5	5	1	—	3-12	A1	30	32DUC†92B1V2*	32DUC†92W1V2*	32DUC†92F1V2*	32DUC†92N1V2*			
3	3	10	10	1	—	5.5-22	A1	30	32DUD†92B1V2*	32DUD†92W1V2*	32DUD†92F1V2*	32DUD†92N1V2*			
7 1/2	7 1/2	—	—	1	—	10-40	A1	60	32DUE†92B1V2*	32DUE†92W1V2*	32DUE†92F1V2*	32DUE†92N1V2*			
10	10	15	15	—	1 1/2	10-40	A1	60	32EUE†92B1V2*	32EUE†92W1V2*	32EUE†92F1V2*	32EUE†92N1V2*			
10	15	25	25	2	—	13-52	B	60	32FUF†92B1V2*	32FUF†92W1V2*	32FUF†92F1V2*	32FUF†92N1V2*			
15	20	30	30	—	2 1/2	25-100	B	100	32GUG†92B1V2*	32GUG†92W1V2*	32GUG†92F1V2*	32GUG†92N1V2*			
20	25	50	50	3	—	25-100	B	100	32HUG†92B1V2*	32HUG†92W1V2*	32HUG†92F1V2*	32HUG†92N1V2*			
30	40	75	75	—	3 1/2	50-200	B	200	32IUH†92B1V2*	32IUH†92W1V2*	32IUH†92F1V2*	32IUH†92N1V2*			
40	50	100	100	4	—	50-200	B	200	32JUH†92B1V2*	32JUH†92W1V2*	32JUH†92F1V2*	32JUH†92N1V2*			

Note: All starter sizes carry one maximum Hp rating (per the National Electric Code).

① Dual voltage coils not available in modified starters.

② For conduit hubs and conversion instructions, see page 9/110.

③ If motor FLA are unknown, select overload on the basis that low speed FLA will be no greater than 50% of high speed FLA.

Non-Fusible, Constant Horsepower with Solid State Overload, Class 32

Selection

	<p>Replace the (*) with a letter from the coil table. Dual voltage coils are wired on high voltage unless specified on order.</p> <p>Replace the (t) with the letter that corresponds to the correct FLA in the High/Low Speed FLA Table.®</p> <p>Fuse clips see page 9/120.</p> <p>Field Modification Kits see page 9/104.</p> <p>Factory Modifications see page 9/119.</p> <p>Dimensions see page 9/166.</p> <p>Wiring Diagrams see page 9/178.</p> <p>Replacement Parts see page 9/131.</p>	Ordering Information		Coil Table		High/Low Speed FLA Table®			
		<p>60Hz Voltage</p> <p>Letter</p> <p>Size</p> <p>FLA</p> <p>OLR Frame Size</p> <p>†</p>	<p>24</p> <p>120</p> <p>110–120/220–240®</p> <p>200–208</p> <p>220–240</p> <p>277</p> <p>220–240/440–480®</p> <p>440–480</p> <p>575–600</p>	<p>J</p> <p>F</p> <p>A</p> <p>D</p> <p>G</p> <p>L</p> <p>C</p> <p>H</p> <p>E</p>	<p>0,1</p> <p>0,1</p> <p>0,1</p> <p>0,1</p> <p>0-1^{3/4}</p> <p>2-3</p> <p>2-3</p> <p>3^{1/2}-4</p>	<p>0.25–1</p> <p>0.75–3.4</p> <p>3–12</p> <p>5.5–22</p> <p>10–40</p> <p>13–52</p> <p>25–100</p> <p>50–200</p>	<p>A</p> <p>A</p> <p>A1</p> <p>A1</p> <p>A1</p> <p>B</p> <p>B</p> <p>B</p>	<p>A</p> <p>B</p> <p>C</p> <p>D</p> <p>E</p> <p>F</p> <p>G</p> <p>H</p>	
		<p>For other voltages and frequencies see Factory Modifications page 9/119.</p>		<p>* First (t) for high speed, second (†) for low speed. Use motor nameplate to select FLA. If motor FLA are unknown, select overload on the bases that the low speed FLA will be no greater than 50 % of high speed FLA.</p>					

One Winding Consequent Pole, 3-Phase (Constant Horsepower)

Max Hp				NEMA Size	Half Size	Amp Range	Frame Size	Disc. Amp Range	Enclosure						
200 Volts	230 Volts	460 Volts	575 Volts						NEMA 1 General Purpose	NEMA 4/4X Stainless® Watertight, Dust-tight, Corrosion Resistant 304 Stainless Steel	NEMA 4X Fiberglass Watertight, Dust-tight Corrosion Resistant	NEMA 12, NEMA 3/3R®, NEMA 4 Painted Industrial Use Weatherproof Watertight, Dust-tight			
Catalog Number	List Price \$	Catalog Number	List Price \$	Catalog Number	List Price \$	Catalog Number	List Price \$	Catalog Number	List Price \$						
2	2	3	3	0	—	—	—	30	32CU††92B2H2*	32CU††92W2H2*	4054.00	32CU††92F2H2*	32CU††92N2H2*		
5	5	7½	7½	1	—	—	—	30	32DU††92B2H2*	32DU††92W2H2*	4173.00	32DU††92F2H2*	32DU††92N2H2*		
7½	7½	10	10	—	1½	—	—	60	32EU††92B2H2*	32EU††92W2H2*	4873.00	32EU††92F2H2*	32EU††92N2H2*		
7½	10	20	20	2	—	—	—	60	32FU††92B2H2*	32FU††92W2H2*	6146.00	32FU††92F2H2*	32FU††92N2H2*		
10	15	25	25	—	2½	—	—	100	32GU††92B2H2*	32GU††92W2H2*	7219.00	32GU††92F2H2*	32GU††92N2H2*		
20	25	40	40	3	—	—	—	100	32HU††92B2H2*	32HU††92W2H2*	9321.00	32HU††92F2H2*	32HU††92N2H2*		
25	30	50	50	—	3½	—	—	200	32IU††92B2H2*	32IU††92W2H2*	18079.00	32IU††92F2H2*	32IU††92N2H2*		
30	40	75	75	4	—	—	—	200	32JU††92B2H2*	32JU††92W2H2*	19263.00	32JU††92F2H2*	32JU††92N2H2*		

Two Separate Windings, 3-Phase (Constant Horsepower)

Max Hp				NEMA Size	Half Size	Amp Range	Frame Size	Disc. Amp Range	Enclosure						
200 Volts	230 Volts	460 Volts	575 Volts						NEMA 1 General Purpose	NEMA 4/4X Stainless® Watertight, Dust-tight, Corrosion Resistant 304 Stainless Steel	NEMA 4X Fiberglass Watertight, Dust-tight Corrosion Resistant	NEMA 12, NEMA 3/3R®, NEMA 4 Painted Industrial Use Weatherproof Watertight, Dust-tight			
Catalog Number	List Price \$	Catalog Number	List Price \$	Catalog Number	List Price \$	Catalog Number	List Price \$	Catalog Number	List Price \$						
2	2	3	3	0	—	—	—	30	32CU††92B1H2*	32CU††92W1H2*		32CU††92F1H2*	32CU††92N1H2*		
5	5	7½	7½	1	—	—	—	30	32DU††92B1H2*	32DU††92W1H2*		32DU††92F1H2*	32DU††92N1H2*		
7½	7½	10	10	—	1½	—	—	60	32EU††92B1H2*	32EU††92W1H2*		32EU††92F1H2*	32EU††92N1H2*		
7½	10	20	20	2	—	—	—	60	32FU††92B1H2*	32FU††92W1H2*		32FU††92F1H2*	32FU††92N1H2*		
10	15	25	25	—	2½	—	—	100	32GU††92B1H2*	32GU††92W1H2*		32GU††92F1H2*	32GU††92N1H2*		
20	25	40	40	3	—	—	—	100	32HU††92B1H2*	32HU††92W1H2*		32HU††92F1H2*	32HU††92N1H2*		
25	30	50	50	—	3½	—	—	200	32IU††92B1H2*	32IU††92W1H2*		32IU††92F1H2*	32IU††92N1H2*		
30	40	75	75	4	—	—	—	200	32JU††92B1H2*	32JU††92W1H2*		32JU††92F1H2*	32JU††92N1H2*		

Note: All starter sizes carry one maximum Hp rating (per the National Electric Code).

① Dual voltage coils not available in modified starters.

② For conduit hubs and conversion instructions, see page 9/110.

③ First † for high speed, second † for low speed. Use motor nameplate information to select FLA. If motor FLA are unknown, select overload on the basis that low speed FLA will be no greater than 50% of high speed FLA.

Combination Two Speed Heavy Duty Starters

Non-Fusible, Constant or Variable Torque with Ambient Compensated Bimetal Overload, Class 32

Selection



Ordering Information

Replace the (*) with a letter from the coil table. Dual voltage coils are wired on high voltage unless specified on order.

Heater elements see page 9/124. (6 required)

Fuse clips see page 9/120.

Field Modification Kits see page 9/104.

Factory Modifications see page 9/119.

Dimensions see page 9/166.

Wiring Diagrams see page 9/178.

Replacement Parts see page 9/131.

For NO/NC SPDT contact on overload relay, replace "81" with "91". "81" indicates one NC contact.

Coil Table

60Hz Voltage	Letter
24	J
120	F
110-120/220-240 ^①	A
200-208	D
220-240	G
277	L
220-240/440-480 ^①	C
440-480	H
575-600	E

For other voltages and frequencies, see Factory Modifications page 9/119.

One Winding Consequent Pole, 3-Phase (Constant or Variable Torque)

Max Hp				NEMA Size	Disc Half Size	Amp Rating	Enclosure							
200 Volts	230 Volts	460 Volts	575 Volts				NEMA 1 General Purpose		NEMA 4/4X Stainless ^② Watertight, Dust-tight Corrosion Resistant 304 Stainless Steel		NEMA 4X Fiberglass Watertight, Dust-tight Corrosion Resistant		NEMA 12, NEMA 3/3R ^② NEMA 4 Painted Industrial Use Weatherproof Watertight, Dust-tight	
							Catalog Number	List Price \$	Catalog Number	List Price \$	Catalog Number	List Price \$	Catalog Number	List Price \$
3	3	5	5	0	—	30	32CP92B2V2*81		32CP92W2V2*81		32CP92F2V2*81		32CP92N2V2*81	
7½	7½	10	10	1	—	30	32DP92B2V2*81		32DP92W2V2*81		32DP92F2V2*81		32DP92N2V2*81	
10	10	15	15	—	1¼	60	32EP92B2V2*81		32EP92W2V2*81		32EP92F2V2*81		32EP92N2V2*81	
10	15	25	25	2	—	60	32FP92B2V2*81		32FP92W2V2*81		32FP92F2V2*81		32FP92N2V2*81	
15	20	30	30	—	2½	100	32GP92B2V2*81		32GP92W2V2*81		32GP92F2V2*81		32GP92N2V2*81	
20	25	50	50	3	—	100	32HP92B2V2*81		32HP92W2V2*81		32HP92F2V2*81		32HP92N2V2*81	
30	40	75	75	—	3½	200	32IP92B2V2*81		32IP92W2V2*81		32IP92F2V2*81		32IP92N2V2*81	
40	50	100	100	4	—	200	32JP92B2V2*81		32JP92W2V2*81		32JP92F2V2*81		32JP92N2V2*81	

Two Separate Windings, 3-Phase (Constant or Variable Torque)

Max Hp				NEMA Size	Disc Half Size	Amp Rating	Enclosure							
200 Volts	230 Volts	460 Volts	575 Volts				NEMA 1 General Purpose		NEMA 4/4X Stainless ^② Watertight, Dust-tight Corrosion Resistant 304 Stainless Steel		NEMA 4X Fiberglass Watertight, Dust-tight Corrosion Resistant		NEMA 12, NEMA 3/3R ^② NEMA 4 Painted Industrial Use Weatherproof Watertight, Dust-tight	
							Catalog Number	List Price \$	Catalog Number	List Price \$	Catalog Number	List Price \$	Catalog Number	List Price \$
3	3	5	5	0	—	30	32CP92B1V2*81		32CP92W1V2*81		32CP92F1V2*81		32CP92N1V2*81	
7½	7½	10	10	1	—	30	32DP92B1V2*81		32DP92W1V2*81		32DP92F1V2*81		32DP92N1V2*81	
10	10	15	15	—	1¼	60	32EP92B1V2*81		32EP92W1V2*81		32EP92F1V2*81		32EP92N1V2*81	
10	15	25	25	2	—	60	32FP92B1V2*81		32FP92W1V2*81		32FP92F1V2*81		32FP92N1V2*81	
15	20	30	30	—	2½	100	32GP92B1V2*81		32GP92W1V2*81		32GP92F1V2*81		32GP92N1V2*81	
20	25	50	50	3	—	100	32HP92B1V2*81		32HP92W1V2*81		32HP92F1V2*81		32HP92N1V2*81	
30	40	75	75	—	3½	200	32IP92B1V2*81		32IP92W1V2*81		32IP92F1V2*81		32IP92N1V2*81	
40	50	100	100	4	—	200	32JP92B1V2*81		32JP92W1V2*81		32JP92F1V2*81		32JP92N1V2*81	

Note: Hp's shown above are based on the overload amp range for the FLA's (per the National Electric Code) of typical industrial motors. All starter sizes carry one maximum Hp rating.

① Dual voltage coils not available in modified starters.
② For conduit hubs and conversion instructions, see page 9/110.

Selection

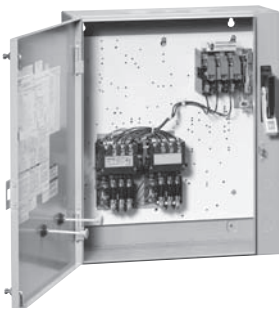
	Ordering Information	Coil Table																			
	<p>Replace the (*) with a letter from the coil table. Dual voltage coils are wired on high voltage unless specified on order.</p> <p>Heater elements see page 9/124. (6 Required)</p> <p>Fuse clips see page 9/120.</p> <p>Field Modification Kits see page 9/104.</p> <p>Factory Modifications see page 9/119.</p> <p>Dimensions see page 9/166.</p> <p>Wiring Diagrams see page 9/178.</p> <p>Replacement Parts see page 9/131.</p> <p>For NO/NC SPDT contact on overload relay, replace "81" with "91". "81" indicates one NC contact..</p>	<table border="1"> <thead> <tr> <th>60Hz Voltage</th> <th>Letter</th> </tr> </thead> <tbody> <tr><td>24</td><td>J</td></tr> <tr><td>120</td><td>F</td></tr> <tr><td>110–120/220–240[ⓐ]</td><td>A</td></tr> <tr><td>200–208</td><td>D</td></tr> <tr><td>220–240</td><td>G</td></tr> <tr><td>277</td><td>L</td></tr> <tr><td>220–240/440–480[ⓐ]</td><td>C</td></tr> <tr><td>440–480</td><td>H</td></tr> <tr><td>575–600</td><td>E</td></tr> </tbody> </table> <p>For other voltages and frequencies, see Factory Modifications page 9/119.</p>	60Hz Voltage	Letter	24	J	120	F	110–120/220–240 [ⓐ]	A	200–208	D	220–240	G	277	L	220–240/440–480 [ⓐ]	C	440–480	H	575–600
60Hz Voltage	Letter																				
24	J																				
120	F																				
110–120/220–240 [ⓐ]	A																				
200–208	D																				
220–240	G																				
277	L																				
220–240/440–480 [ⓐ]	C																				
440–480	H																				
575–600	E																				

One Winding Consequent Pole, 3-Phase (Constant Horsepower)

Max Hp				NEMA Size	Disc Half Size	Amp Rating	Enclosure							
200 Volts	230 Volts	460 Volts	575 Volts				NEMA 1 General Purpose		NEMA 4/4X Stainless [ⓐ] Watertight, Dust-tight Corrosion Resistant 304 Stainless Steel		NEMA 4X Fiberglass Watertight, Dust-tight Corrosion Resistant		NEMA 12, NEMA 3/3R [ⓑ] NEMA 4 Painted Industrial Use Weatherproof Watertight, Dust-tight	
							Catalog Number	List Price \$	Catalog Number	List Price \$	Catalog Number	List Price \$	Catalog Number	List Price \$
2	2	3	3	0	—	30	32CP92B2H2*81		32CP92W2H2*81		32CP92F2H2*81		32CP92N2H2*81	
5	5	7½	7½	1	—	30	32DP92B2H2*81		32DP92W2H2*81		32DP92F2H2*81		32DP92N2H2*81	
7½	7½	10	10	—	1¼	60	32EP92B2H2*81		32EP92W2H2*81		32EP92F2H2*81		32EP92N2H2*81	
7½	10	20	20	2	—	60	32FP92B2H2*81		32FP92W2H2*81		32FP92F2H2*81		32FP92N2H2*81	
10	15	25	25	—	2½	100	32GP92B2H2*81		32GP92W2H2*81		32GP92F2H2*81		32GP92N2H2*81	
20	25	40	40	3	—	100	32HP92B2H2*81		32HP92W2H2*81		32HP92F2H2*81		32HP92N2H2*81	
25	30	50	50	—	3½	200	32IP92B2H2*81		32IP92W2H2*81		32IP92F2H2*81		32IP92N2H2*81	
30	40	75	75	4	—	200	32JP92B2H2*81		32JP92W2H2*81		32JP92F2H2*81		32JP92N2H2*81	

Two Separate Windings, 3-Phase (Constant Horsepower)

Max Hp				NEMA Size	Half Size	Disc Amp Rating	Enclosure							
200 Volts	230 Volts	460 Volts	575 Volts				NEMA 1 General Purpose		NEMA 4/4X Stainless [ⓐ] Watertight, Dust-tight Corrosion Resistant 304 Stainless Steel		NEMA 4X Fiberglass Watertight, Dust-tight Corrosion Resistant		NEMA 12, NEMA 3/3R [ⓑ] NEMA 4 Painted Industrial Use Weatherproof Watertight, Dust-tight	
							Catalog Number	List Price \$	Catalog Number	List Price \$	Catalog Number	List Price \$	Catalog Number	List Price \$
2	2	3	3	0	—	30	32CP92B1H2*81		32CP92W1H2*81		32CP92F1H2*81		32CP92N1H2*81	
5	5	7½	7½	1	—	30	32DP92B1H2*81		32DP92W1H2*81		32DP92F1H2*81		32DP92N1H2*81	
7½	7½	10	10	—	1¼	60	32EP92B1H2*81		32EP92W1H2*81		32EP92F1H2*81		32EP92N1H2*81	
7½	10	20	20	2	—	60	32FP92B1H2*81		32FP92W1H2*81		32FP92F1H2*81		32FP92N1H2*81	
10	15	25	25	—	2½	100	32GP92B1H2*81		32GP92W1H2*81		32GP92F1H2*81		32GP92N1H2*81	
20	25	40	40	3	—	100	32HP92B1H2*81		32HP92W1H2*81		32HP92F1H2*81		32HP92N1H2*81	
25	30	50	50	—	3½	200	32IP92B1H2*81		32IP92W1H2*81		32IP92F1H2*81		32IP92N1H2*81	
30	40	75	75	4	—	200	32JP92B1H2*81		32JP92W1H2*81		32JP92F1H2*81		32JP92N1H2*81	

Note: Hp's shown above are based on the overload amp range for the FLA's (per the National Electric Code) of typical industrial motors. All starter sizes carry one maximum Hp rating.

ⓐ Dual voltage coils not available in modified starters.
 ⓑ For conduit hubs and conversion instructions, see page 9/110.

MCP Type, Constant or Variable Torque with Solid State Overload, Class 32

Selection

	Ordering Information	Coil Table	Low Speed FLA Table																																																														
	<p>Replace the (*) with a letter from the coil table. Dual voltage coils are wired on high voltage unless specified on order.</p> <p>Replace the (t) with the letter that corresponds to the correct low speed FLA in the FLA table.®</p> <p>Field Modification Kits see page 9/104.</p> <p>Factory Modifications see page 9/119.</p> <p>Dimensions see page 9/166.</p> <p>Wiring Diagrams see page 9/178.</p> <p>Replacement Parts see page 9/131.</p>	<table border="1"> <thead> <tr> <th>60Hz Voltage</th> <th>Letter</th> <th>Size</th> <th>FLA</th> <th>OLR Frame Size</th> <th>†</th> </tr> </thead> <tbody> <tr> <td>24</td> <td>J</td> <td>0,1</td> <td>0.25-1</td> <td>A</td> <td>A</td> </tr> <tr> <td>120</td> <td>F</td> <td>0,1</td> <td>0.75-3.4</td> <td>A</td> <td>B</td> </tr> <tr> <td>110-120/220-240[ⓐ]</td> <td>A</td> <td>0,1</td> <td>3-12</td> <td>A1</td> <td>C</td> </tr> <tr> <td>200-208</td> <td>D</td> <td>0,1</td> <td>5.5-22</td> <td>A1</td> <td>D</td> </tr> <tr> <td>220-240</td> <td>G</td> <td>0-1^{3/4}</td> <td>10-40</td> <td>A1</td> <td>E</td> </tr> <tr> <td>277</td> <td>L</td> <td>2-3</td> <td>13-52</td> <td>B</td> <td>F</td> </tr> <tr> <td>220-240/440-480[ⓐ]</td> <td>C</td> <td>2-3</td> <td>25-100</td> <td>B</td> <td>G</td> </tr> <tr> <td>440-480</td> <td>H</td> <td>3^{1/2}-4</td> <td>50-200</td> <td>B</td> <td>H</td> </tr> <tr> <td>575-600</td> <td>E</td> <td></td> <td></td> <td></td> <td></td> </tr> </tbody> </table> <p>For other voltages and frequencies, see Factory Modifications page 9/119.</p>	60Hz Voltage	Letter	Size	FLA	OLR Frame Size	†	24	J	0,1	0.25-1	A	A	120	F	0,1	0.75-3.4	A	B	110-120/220-240 [ⓐ]	A	0,1	3-12	A1	C	200-208	D	0,1	5.5-22	A1	D	220-240	G	0-1 ^{3/4}	10-40	A1	E	277	L	2-3	13-52	B	F	220-240/440-480 [ⓐ]	C	2-3	25-100	B	G	440-480	H	3 ^{1/2} -4	50-200	B	H	575-600	E							
60Hz Voltage	Letter	Size	FLA	OLR Frame Size	†																																																												
24	J	0,1	0.25-1	A	A																																																												
120	F	0,1	0.75-3.4	A	B																																																												
110-120/220-240 [ⓐ]	A	0,1	3-12	A1	C																																																												
200-208	D	0,1	5.5-22	A1	D																																																												
220-240	G	0-1 ^{3/4}	10-40	A1	E																																																												
277	L	2-3	13-52	B	F																																																												
220-240/440-480 [ⓐ]	C	2-3	25-100	B	G																																																												
440-480	H	3 ^{1/2} -4	50-200	B	H																																																												
575-600	E																																																																

One Winding Consequent Pole, 3-Phase (Constant or Variable Torque)

Max Hp				NEMA Size	Half Size	Motor Circuit Interrupter ETI Amps	Overload		Enclosure							
200 Volts	230 Volts	460 Volts	575 Volts				Amp Range	Frame Size	NEMA 1 General Purpose		NEMA 4/4X Stainless [ⓐ] Watertight, Dust-tight, Corrosion Resistant 304 Stainless Steel		NEMA 4X Fiberglass Watertight, Dust-tight Corrosion Resistant		NEMA 12, NEMA 3/3R [ⓐ] , NEMA 4 Painted Industrial Use Weatherproof Watertight, Dust-tight	
Catalog Number	List Price \$	Catalog Number	List Price \$				Catalog Number	List Price \$	Catalog Number	List Price \$	Catalog Number	List Price \$	Catalog Number	List Price \$	Catalog Number	List Price \$
1/2	3/4	1 1/2	2	0	—	3	0.75-3.4	A	32CUB†92B2V*	32CUB†92W2V*	32CUB†92F2V*	32CUB†92N2V*				
2	2	5	5	0	—	10	3-12	A1	32CUC†92B2V*	32CUC†92W2V*	32CUC†92F2V*	32CUC†92N2V*				
3	3	—	—	0	—	25	5.5-22	A1	32CUD†92B2V*	32CUD†92W2V*	32CUD†92F2V*	32CUD†92N2V*				
1/2	3/4	1 1/2	1 1/2	1	—	3	0.75-3.4	A	32DUB†92B2V*	32DUB†92W2V*	32DUB†92F2V*	32DUB†92N2V*				
2	2	5	5	1	—	10	3-12	A1	32DUC†92B2V*	32DUC†92W2V*	32DUC†92F2V*	32DUC†92N2V*				
3	3	10	10	1	—	25	5.5-22	A1	32DUD†92B2V*	32DUD†92W2V*	32DUD†92F2V*	32DUD†92N2V*				
7 1/2	7 1/2	—	—	1	—	30	10-40	A1	32DUE†92B2V*	32DUE†92W2V*	32DUE†92F2V*	32DUE†92N2V*				
—	—	15	15	—	1 1/2	40	10-40	A1	32EUE†92B2V*	32EUE†92W2V*	32EUE†92F2V*	32EUE†92N2V*				
10	15	25	25	2	—	50	13-52	B	32FUF†92B2V*	32FUF†92W2V*	32FUF†92F2V*	32FUF†92N2V*				
15	20	30	30	—	2 1/2	100	25-100	B	32GUG†92B2V*	32GUG†92W2V*	32GUG†92F2V*	32GUG†92N2V*				
25	30	50	50	3	—	125	25-100	B	32HUG†92B2V*	32HUG†92W2V*	32HUG†92F2V*	32HUG†92N2V*				
30	40	75	75	—	3 1/2	125	50-200	B	32IUH†92B2V*	32IUH†92W2V*	32IUH†92F2V*	32IUH†92N2V*				
40	50	100	100	4	—	150	50-200	B	32JUH†92B2V*	32JUH†92W2V*	32JUH†92F2V*	32JUH†92N2V*				

Two Separate Windings, 3-Phase (Constant or Variable Torque)

Max Hp				NEMA Size	Half Size	Motor Circuit Interrupter ETI Amps	Overload		Enclosure							
200 Volts	230 Volts	460 Volts	575 Volts				Amp Range	Frame Size	NEMA 1 General Purpose		NEMA 4/4X Stainless [ⓐ] Watertight, Dust-tight, Corrosion Resistant 304 Stainless Steel		NEMA 4X Fiberglass Watertight, Dust-tight Corrosion Resistant		NEMA 12, NEMA 3/3R [ⓐ] , NEMA 4 Painted Industrial Use Weatherproof Watertight, Dust-tight	
Catalog Number	List Price \$	Catalog Number	List Price \$				Catalog Number	List Price \$	Catalog Number	List Price \$	Catalog Number	List Price \$	Catalog Number	List Price \$	Catalog Number	List Price \$
1/2	3/4	1 1/2	2	0	—	3	0.75-3.4	A	32CUB†92B1V*	32CUB†92W1V*	32CUB†92F1V*	32CUB†92N1V*				
2	2	5	5	0	—	10	3-12	A1	32CUC†92B1V*	32CUC†92W1V*	32CUC†92F1V*	32CUC†92N1V*				
3	3	—	—	0	—	25	5.5-22	A1	32CUD†92B1V*	32CUD†92W1V*	32CUD†92F1V*	32CUD†92N1V*				
1/2	3/4	1 1/2	1 1/2	1	—	3	0.75-3.4	A	32DUB†92B1V*	32DUB†92W1V*	32DUB†92F1V*	32DUB†92N1V*				
2	2	5	5	1	—	10	3-12	A1	32DUC†92B1V*	32DUC†92W1V*	32DUC†92F1V*	32DUC†92N1V*				
3	3	10	10	1	—	25	5.5-22	A1	32DUD†92B1V*	32DUD†92W1V*	32DUD†92F1V*	32DUD†92N1V*				
7 1/2	7 1/2	—	—	1	—	30	10-40	A1	32DUE†92B1V*	32DUE†92W1V*	32DUE†92F1V*	32DUE†92N1V*				
—	—	15	15	—	1 1/2	40	10-40	A1	32EUE†92B1V*	32EUE†92W1V*	32EUE†92F1V*	32EUE†92N1V*				
10	15	25	25	2	—	50	13-52	B	32FUF†92B1V*	32FUF†92W1V*	32FUF†92F1V*	32FUF†92N1V*				
15	20	30	30	—	2 1/2	100	25-100	B	32GUG†92B1V*	32GUG†92W1V*	32GUG†92F1V*	32GUG†92N1V*				
25	30	50	50	3	—	125	25-100	B	32HUG†92B1V*	32HUG†92W1V*	32HUG†92F1V*	32HUG†92N1V*				
30	40	75	75	—	3 1/2	125	50-200	B	32IUH†92B1V*	32IUH†92W1V*	32IUH†92F1V*	32IUH†92N1V*				
40	50	100	100	4	—	150	50-200	B	32JUH†92B1V*	32JUH†92W1V*	32JUH†92F1V*	32JUH†92N1V*				

Note: All starter sizes carry one maximum Hp rating (per the National Electric Code).

ⓐ Dual voltage coils not available in modified starters.

ⓑ For conduit hubs and conversion instructions, see page 9/110.

ⓒ If motor FLA are unknown, select overload on the basis that low speed FLA will be no greater than 50% of high speed FLA.

MCP Type, Constant Horsepower with Solid State Overload, Class 32

Selection

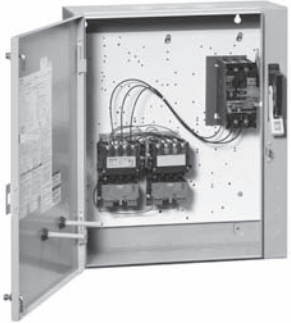
	<p>Replace the (*) with a letter from the coil table. Dual voltage coils are wired on high voltage unless specified on order.</p> <p>Replace the (†) with the letter that corresponds to the correct FLA in the High/Low Speed FLA table.®</p> <p>Field Modification Kits see page 9/104.</p> <p>Factory Modifications see page 9/119.</p> <p>Dimensions see page 9/166.</p> <p>Wiring Diagrams see page 9/178.</p> <p>Replacement Parts see page 9/131.</p>	Coil Table		High/Low Speed FLA Table®																																																												
		<table border="1"> <thead> <tr> <th>60Hz Voltage</th> <th>Letter</th> <th>Size</th> <th>FLA</th> <th>OLR Frame Size</th> <th>†</th> </tr> </thead> <tbody> <tr> <td>24</td> <td>J</td> <td>0,1</td> <td>0.25-1</td> <td>A</td> <td>A</td> </tr> <tr> <td>120</td> <td>F</td> <td>0,1</td> <td>0.75-3.4</td> <td>A</td> <td>B</td> </tr> <tr> <td>110-120/220-240[ⓐ]</td> <td>A</td> <td>0,1</td> <td>3-12</td> <td>A1</td> <td>C</td> </tr> <tr> <td>200-208</td> <td>D</td> <td>0,1</td> <td>5.5-22</td> <td>A1</td> <td>D</td> </tr> <tr> <td>220-240</td> <td>G</td> <td>0-1^{3/4}</td> <td>10-40</td> <td>A1</td> <td>E</td> </tr> <tr> <td>277</td> <td>L</td> <td>2-3</td> <td>13-52</td> <td>B</td> <td>F</td> </tr> <tr> <td>220-240/440-480[ⓐ]</td> <td>C</td> <td>2-3</td> <td>25-100</td> <td>B</td> <td>G</td> </tr> <tr> <td>440-480</td> <td>H</td> <td>3^{1/2}-4</td> <td>50-200</td> <td>B</td> <td>H</td> </tr> <tr> <td>575-600</td> <td>E</td> <td></td> <td></td> <td></td> <td></td> </tr> </tbody> </table>	60Hz Voltage	Letter	Size	FLA	OLR Frame Size	†	24	J	0,1	0.25-1	A	A	120	F	0,1	0.75-3.4	A	B	110-120/220-240 [ⓐ]	A	0,1	3-12	A1	C	200-208	D	0,1	5.5-22	A1	D	220-240	G	0-1 ^{3/4}	10-40	A1	E	277	L	2-3	13-52	B	F	220-240/440-480 [ⓐ]	C	2-3	25-100	B	G	440-480	H	3 ^{1/2} -4	50-200	B	H	575-600	E					<p>* First (†) for high speed, second (†) for low speed. Use motor nameplate to select FLA. If motor FLA are unknown, select overload on the bases that the low speed FLA will be no greater than 50 % of high speed FLA.</p>	
60Hz Voltage	Letter	Size	FLA	OLR Frame Size	†																																																											
24	J	0,1	0.25-1	A	A																																																											
120	F	0,1	0.75-3.4	A	B																																																											
110-120/220-240 [ⓐ]	A	0,1	3-12	A1	C																																																											
200-208	D	0,1	5.5-22	A1	D																																																											
220-240	G	0-1 ^{3/4}	10-40	A1	E																																																											
277	L	2-3	13-52	B	F																																																											
220-240/440-480 [ⓐ]	C	2-3	25-100	B	G																																																											
440-480	H	3 ^{1/2} -4	50-200	B	H																																																											
575-600	E																																																															
		<p>For other voltages and frequencies see Factory Modifications page 9/119.</p>																																																														

One Winding Consequent Pole, 3-Phase (Constant Horsepower)

Max Hp						Motor Circuit Interrupter ETI Amps	Amp Range	Frame Size	Enclosure							
200 Volts	230 Volts	460 Volts	575 Volts	NEMA Size	Half Size				NEMA 1 General Purpose		NEMA 4/4X Stainless [ⓐ] Watertight, Dust-tight, Corrosion Resistant 304 Stainless Steel		NEMA 4X Fiberglass Watertight, Dust-tight Corrosion Resistant		NEMA 12, NEMA 3/3R [ⓐ] , NEMA 4 Painted Industrial Use Weatherproof Watertight, Dust-tight	
2	2	3	3	0	—				10	—	A or A1	Catalog Number	List Price \$	Catalog Number	List Price \$	Catalog Number
2	2	3	3	0	—	10	—	A or A1	32CU††92B2H*		32CU††92W2H*		32CU††92F2H*		32CU††92N2H*	
5	5	7½	7½	1	—	25	—	A or A1	32DU††92B2H*		32DU††92W2H*		32DU††92F2H*		32DU††92N2H*	
7½	7½	10	10	—	1½	40	—	A1	32EU††92B2H*		32EU††92W2H*		32EU††92F2H*		32EU††92N2H*	
7½	10	20	20	2	—	50	—	B	32FU††92B2H*		32FU††92W2H*		32FU††92F2H*		32FU††92N2H*	
10	15	25	25	—	2½	100	—	B	32GU††92B2H*		32GU††92W2H*		32GU††92F2H*		32GU††92N2H*	
20	25	40	40	3	—	100	—	B	32HU††92B2H*		32HU††92W2H*		32HU††92F2H*		32HU††92N2H*	
25	30	50	50	—	3½	125	—	B	32IU††92B2H*		32IU††92W2H*		32IU††92F2H*		32IU††92N2H*	
30	40	75	75	4	—	150	—	B	32JU††92B2H*		32JU††92W2H*		32JU††92F2H*		32JU††92N2H*	

Two Separate Windings, 3-Phase (Constant Horsepower)

Max Hp						Motor Circuit Interrupter ETI Amps	Amp Range	Frame Size	Enclosure							
200 Volts	230 Volts	460 Volts	575 Volts	NEMA Size	Half Size				NEMA 1 General Purpose		NEMA 4/4X Stainless [ⓐ] Watertight, Dust-tight, Corrosion Resistant 304 Stainless Steel		NEMA 4X Fiberglass Watertight, Dust-tight Corrosion Resistant		NEMA 12, NEMA 3/3R [ⓐ] , NEMA 4 Painted Industrial Use Weatherproof Watertight, Dust-tight	
2	2	3	3	0	—				10	—	A or A1	Catalog Number	List Price \$	Catalog Number	List Price \$	Catalog Number
2	2	3	3	0	—	10	—	A or A1	32CU††92B1H*		32CU††92W1H*		32CU††92F1H*		32CU††92N1H*	
5	5	7½	7½	1	—	25	—	A or A1	32DU††92B1H*		32DU††92W1H*		32DU††92F1H*		32DU††92N1H*	
7½	7½	10	10	—	1½	40	—	A1	32EU††92B1H*		32EU††92W1H*		32EU††92F1H*		32EU††92N1H*	
7½	10	20	20	2	—	50	—	B	32FU††92B1H*		32FU††92W1H*		32FU††92F1H*		32FU††92N1H*	
10	15	25	25	—	2½	100	—	B	32GU††92B1H*		32GU††92W1H*		32GU††92F1H*		32GU††92N1H*	
20	25	40	40	3	—	100	—	B	32HU††92B1H*		32HU††92W1H*		32HU††92F1H*		32HU††92N1H*	
25	30	50	50	—	3½	125	—	B	32IU††92B1H*		32IU††92W1H*		32IU††92F1H*		32IU††92N1H*	
30	40	75	75	4	—	150	—	B	32JU††92B1H*		32JU††92W1H*		32JU††92F1H*		32JU††92N1H*	

Note: All starter sizes carry one maximum Hp rating (per the National Electric Code).

ⓐ Dual voltage coils not available in modified starters.

ⓑ For conduit hubs and conversion instructions, see page 9/110.

ⓒ First † for high speed, second † for low speed. Use motor nameplate information to select FLA. If motor FLA are unknown, select overload on the basis that low speed FLA will be no greater than 50% of high speed FLA.

Selection

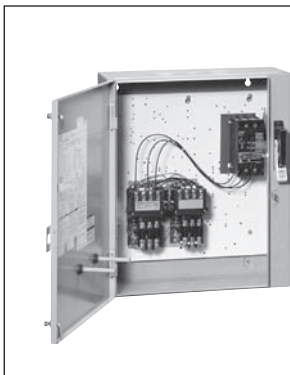

Ordering Information	Coil Table																				
Replace the (*) with a letter from the coil table. Dual voltage coils are wired on high voltage unless specified on order. Heater elements see page 9/124. (6 Required) Field Modification Kits see page 9/104. Factory Modifications see page 9/119. Dimensions see page 9/166. Wiring Diagrams see page 9/178. Replacement Parts see page 9/131. For NO/NC SPDT contact on overload relay, replace "81" with "91". "81" indicates one NC contact.	<table border="1"> <thead> <tr> <th>60Hz Voltage</th> <th>Letter</th> </tr> </thead> <tbody> <tr><td>24</td><td>J</td></tr> <tr><td>120</td><td>F</td></tr> <tr><td>110–120/220–240[Ⓛ]</td><td>A</td></tr> <tr><td>200–208</td><td>D</td></tr> <tr><td>220–240</td><td>G</td></tr> <tr><td>277</td><td>L</td></tr> <tr><td>220–240/440–480[Ⓛ]</td><td>C</td></tr> <tr><td>440–480</td><td>H</td></tr> <tr><td>575–600</td><td>E</td></tr> </tbody> </table> For other voltages and frequencies, see Factory Modifications page 9/119.	60Hz Voltage	Letter	24	J	120	F	110–120/220–240 [Ⓛ]	A	200–208	D	220–240	G	277	L	220–240/440–480 [Ⓛ]	C	440–480	H	575–600	E
60Hz Voltage	Letter																				
24	J																				
120	F																				
110–120/220–240 [Ⓛ]	A																				
200–208	D																				
220–240	G																				
277	L																				
220–240/440–480 [Ⓛ]	C																				
440–480	H																				
575–600	E																				

One Winding Consequent Pole, 3-Phase (Constant or Variable Torque)

Max Hp				NEMA Size	Half Size	Motor Circuit Interrupter ETI Amps	Enclosure							
200 Volts	230 Volts	460 Volts	575 Volts				NEMA 1 General Purpose		NEMA 4/4X Stainless [Ⓛ] Watertight, Dust-tight Corrosion Resistant 304 Stainless Steel		NEMA 4X Fiberglass Watertight, Dust-tight Corrosion Resistant		NEMA 12, NEMA 3/3R [Ⓛ] NEMA 4 Painted Industrial Use Weatherproof Watertight, Dust-tight	
							Catalog Number	List Price \$	Catalog Number	List Price \$	Catalog Number	List Price \$	Catalog Number	List Price \$
1/2	1/2	1	1	0	—	3	32CP92B2VA*81		32CP92W2VA*81		32CP92F2VA*81		32CP92N2VA*81	
1	1	3	3	0	—	10	32CP92B2VB*81		32CP92W2VB*81		32CP92F2VB*81		32CP92N2VB*81	
3	3	5	5	0	—	25	32CP92B2VC*81		32CP92W2VC*81		32CP92F2VC*81		32CP92N2VC*81	
1 1/2	1 1/2	1	1	1	—	3	32DP92B2VA*81		32DP92W2VA*81		32DP92F2VA*81		32DP92N2VA*81	
1	1	3	3	1	—	10	32DP92B2VB*81		32DP92W2VB*81		32DP92F2VB*81		32DP92N2VB*81	
3	3	7 1/2	7 1/2	1	—	25	32DP92B2VD*81		32DP92W2VD*81		32DP92F2VD*81		32DP92N2VD*81	
7 1/2	7 1/2	10	10	1	—	30	32DP92B2VE*81		32DP92W2VE*81		32DP92F2VE*81		32DP92N2VE*81	
—	—	15	15	—	1 1/4	40	32EP92B2VF*81		32EP92W2VF*81		32EP92F2VF*81		32EP92N2VF*81	
10	10	—	—	—	1 1/4	50	32EP92B2VG*81		32EP92W2VG*81		32EP92F2VG*81		32EP92N2VG*81	
—	—	20	20	2	—	40	32FP92B2VH*81		32FP92W2VH*81		32FP92F2VH*81		32FP92N2VH*81	
10	15	25	25	2	—	50	32FP92B2VJ*81		32FP92W2VJ*81		32FP92F2VJ*81		32FP92N2VJ*81	
10	15	30	30	—	2 1/2	50	32GP92B2VK*81		32GP92W2VK*81		32GP92F2VK*81		32GP92N2VK*81	
15	20	—	—	—	2 1/2	100	32GP92B2VL*81		32GP92W2VL*81		32GP92F2VL*81		32GP92N2VL*81	
—	—	30	30	3	—	50	32HP92B2VM*81		32HP92W2VM*81		32HP92F2VM*81		32HP92N2VM*81	
25	30	50	50	3	—	125	32HP92B2VN*81		32HP92W2VN*81		32HP92F2VN*81		32HP92N2VN*81	
30	40	75	75	—	3 1/2	125	32IP92B2VP*81		32IP92W2VP*81		32IP92F2VP*81		32IP92N2VP*81	
40	50	100	100	4	—	150	32JP92B2VR*81		32JP92W2VR*81		32JP92F2VR*81		32JP92N2VR*81	

Two Separate Windings, 3-Phase (Constant or Variable Torque)

Max Hp				NEMA Size	Half Size	Motor Circuit Interrupter ETI Amps	Enclosure							
200 Volts	230 Volts	460 Volts	575 Volts				NEMA 1 General Purpose		NEMA 4/4X Stainless [Ⓛ] Watertight, Dust-tight Corrosion Resistant 304 Stainless Steel		NEMA 4X Fiberglass Watertight, Dust-tight Corrosion Resistant		NEMA 12, NEMA 3/3R [Ⓛ] NEMA 4 Painted Industrial Use Weatherproof Watertight, Dust-tight	
							Catalog Number	List Price \$	Catalog Number	List Price \$	Catalog Number	List Price \$	Catalog Number	List Price \$
1/2	1/2	1	1	0	—	3	32CP92B1VA*81		32CP92W1VA*81		32CP92F1VA*81		32CP92N1VA*81	
1	1	3	3	0	—	10	32CP92B1VB*81		32CP92W1VB*81		32CP92F1VB*81		32CP92N1VB*81	
3	3	5	5	0	—	25	32CP92B1VC*81		32CP92W1VC*81		32CP92F1VC*81		32CP92N1VC*81	
1/2	1/2	1	1	1	—	3	32DP92B1VA*81		32DP92W1VA*81		32DP92F1VA*81		32DP92N1VA*81	
1	1	3	3	1	—	10	32DP92B1VB*81		32DP92W1VB*81		32DP92F1VB*81		32DP92N1VB*81	
3	3	7 1/2	7 1/2	1	—	25	32DP92B1VD*81		32DP92W1VD*81		32DP92F1VD*81		32DP92N1VD*81	
7 1/2	7 1/2	10	10	1	—	30	32DP92B1VE*81		32DP92W1VE*81		32DP92F1VE*81		32DP92N1VE*81	
—	—	15	15	—	1 1/4	40	32EP92B1VF*81		32EP92W1VF*81		32EP92F1VF*81		32EP92N1VF*81	
10	10	—	—	—	1 1/4	50	32EP92B1VG*81		32EP92W1VG*81		32EP92F1VG*81		32EP92N1VG*81	
—	—	20	20	2	—	40	32FP92B1VH*81		32FP92W1VH*81		32FP92F1VH*81		32FP92N1VH*81	
10	15	25	25	2	—	50	32FP92B1VJ*81		32FP92W1VJ*81		32FP92F1VJ*81		32FP92N1VJ*81	
10	15	30	30	—	2 1/2	50	32GP92B1VK*81		32GP92W1VK*81		32GP92F1VK*81		32GP92N1VK*81	
15	20	—	—	—	2 1/2	100	32GP92B1VL*81		32GP92W1VL*81		32GP92F1VL*81		32GP92N1VL*81	
—	—	30	30	3	—	50	32HP92B1VM*81		32HP92W1VM*81		32HP92F1VM*81		32HP92N1VM*81	
25	30	50	50	3	—	125	32HP92B1VN*81		32HP92W1VN*81		32HP92F1VN*81		32HP92N1VN*81	
30	40	75	75	—	3 1/2	125	32IP92B1VP*81		32IP92W1VP*81		32IP92F1VP*81		32IP92N1VP*81	
40	50	100	100	4	—	150	32JP92B1VR*81		32JP92W1VR*81		32JP92F1VR*81		32JP92N1VR*81	

Note: Hp's shown above are based on the overload amp range for the FLA's (per the National Electric Code) of typical industrial motors. All starter sizes carry one maximum Hp rating.

Ⓛ Dual voltage coils not available in modified starters.
 Ⓛ For conduit hubs and conversion instructions, see page 9/110.

6 GENERAL PURPOSE CONTROL

MCP, Constant Horsepower w/ Ambient Compensated Bimetal Overload, Class 32

Selection

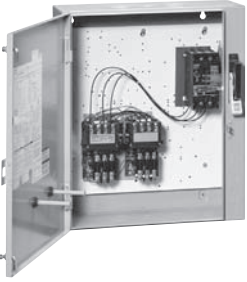
	Ordering Information Replace the (*) with a letter from the coil table. Dual voltage coils are wired on high voltage unless specified on order. Heater elements see page 9/124. (6 Required) Field Modification Kits see page 9/104. Factory Modifications see page 9/119. Dimensions see page 9/166. Wiring Diagrams see page 9/178. Replacement Parts see page 9/131. For NO/NC SPDT contact on overload relay, replace "81" with "91". "81" indicates one NC contact..	Coil Table <table border="1"> <thead> <tr> <th>60Hz Voltage</th> <th>Letter</th> </tr> </thead> <tbody> <tr><td>24</td><td>J</td></tr> <tr><td>120</td><td>F</td></tr> <tr><td>110-120/220-240^①</td><td>A</td></tr> <tr><td>200-208</td><td>D</td></tr> <tr><td>220-240</td><td>G</td></tr> <tr><td>277</td><td>L</td></tr> <tr><td>220-240/440-480^①</td><td>C</td></tr> <tr><td>440-480</td><td>H</td></tr> <tr><td>575-600</td><td>E</td></tr> </tbody> </table> For other voltages and frequencies, see Factory Modifications page 9/119.	60Hz Voltage	Letter	24	J	120	F	110-120/220-240 ^①	A	200-208	D	220-240	G	277	L	220-240/440-480 ^①	C	440-480	H	575-600	E
	60Hz Voltage	Letter																				
24	J																					
120	F																					
110-120/220-240 ^①	A																					
200-208	D																					
220-240	G																					
277	L																					
220-240/440-480 ^①	C																					
440-480	H																					
575-600	E																					

One Winding Consequent Pole, 3-Phase (Constant Horsepower)

Max Hp						Motor Circuit Interrupter ETI Amps	Enclosure							
200 Volts	230 Volts	460 Volts	575 Volts	NEMA Size	Half Size		NEMA 1 General Purpose		NEMA 4/4X Stainless ^② Watertight, Dust-tight Corrosion Resistant 304 Stainless Steel		NEMA 4X Fiberglass Watertight, Dust-tight Corrosion Resistant		NEMA 12, NEMA 3/3R ^② NEMA 4 Painted Industrial Use Weatherproof Watertight, Dust-tight	
							Catalog Number	List Price\$	Catalog Number	List Price\$	Catalog Number	List Price\$	Catalog Number	List Price\$
1/2	1/2	1	1	0	—	3	32CP92B2HA*81		32CP92W2HA*81		32CP92F2HA*81		32CP92N2HA*81	
1 1/2	1 1/2	3	3	0	—	10	32CP92B2HB*81		32CP92W2HB*81		32CP92F2HB*81		32CP92N2HB*81	
2	2	—	—	0	—	25	32CP92B2HC*81		32CP92W2HC*81		32CP92F2HC*81		32CP92N2HC*81	
1/2	1/2	1	1	1	—	3	32DP92B2HA*81		32DP92W2HA*81		32DP92F2HA*81		32DP92N2HA*81	
1 1/2	1 1/2	3	3	1	—	10	32DP92B2HB*81		32DP92W2HB*81		32DP92F2HB*81		32DP92N2HB*81	
3	3	7 1/2	7 1/2	1	—	25	32DP92B2HD*81		32DP92W2HD*81		32DP92F2HD*81		32DP92N2HD*81	
5	5	—	—	1	—	30	32DP92B2HE*81		32DP92W2HE*81		32DP92F2HE*81		32DP92N2HE*81	
—	—	10	10	—	1 3/4	40	32EP92B2HF*81		32EP92W2HF*81		32EP92F2HF*81		32EP92N2HF*81	
7 1/2	7 1/2	—	—	—	1 3/4	50	32EP92B2HG*81		32EP92W2HG*81		32EP92F2HG*81		32EP92N2HG*81	
—	7 1/2	15	20	2	—	40	32FP92B2HH*81		32FP92W2HH*81		32FP92F2HH*81		32FP92N2HH*81	
7 1/2	10	20	—	2	—	50	32FP92B2HJ*81		32FP92W2HJ*81		32FP92F2HJ*81		32FP92N2HJ*81	
—	—	30	30	—	2 1/2	50	32GP92B2HK*81		32GP92W2HK*81		32GP92F2HK*81		32GP92N2HK*81	
10	15	30	40	3	—	50	32HP92B2HM*81		32HP92W2HM*81		32HP92F2HM*81		32HP92N2HM*81	
20	25	40	—	3	—	100	32HP92B2HN*81		32HP92W2HN*81		32HP92F2HN*81		32HP92N2HN*81	
25	30	50	50	—	3 1/2	125	32IP92B2HP*81		32IP92W2HP*81		32IP92F2HP*81		32IP92N2HP*81	
30	40	75	75	4	—	150	32JP92B2HR*81		32JP92W2HR*81		32JP92F2HR*81		32JP92N2HR*81	

Two Separate Windings, 3-Phase (Constant Horsepower)

Max Hp						Motor Circuit Interrupter ETI Amps	Enclosure							
200 Volts	230 Volts	460 Volts	575 Volts	NEMA Size	Half Size		NEMA 1 General Purpose		NEMA 4/4X Stainless ^② Watertight, Dust-tight Corrosion Resistant 304 Stainless Steel		NEMA 4X Fiberglass Watertight, Dust-tight Corrosion Resistant		NEMA 12, NEMA 3/3R ^② NEMA 4 Painted Industrial Use Weatherproof Watertight, Dust-tight	
							Catalog Number	List Price\$	Catalog Number	List Price\$	Catalog Number	List Price\$	Catalog Number	List Price\$
1/2	1/2	1	1	0	—	3	32CP92B1HA*81		32CP92W1HA*81		32CP92F1HA*81		32CP92N1HA*81	
1 1/2	1 1/2	3	3	0	—	10	32CP92B1HB*81		32CP92W1HB*81		32CP92F1HB*81		32CP92N1HB*81	
2	2	—	—	0	—	25	32CP92B1HC*81		32CP92W1HC*81		32CP92F1HC*81		32CP92N1HC*81	
1/2	1/2	1	1	1	—	3	32DP92B1HA*81		32DP92W1HA*81		32DP92F1HA*81		32DP92N1HA*81	
1 1/2	1 1/2	3	3	1	—	10	32DP92B1HB*81		32DP92W1HB*81		32DP92F1HB*81		32DP92N1HB*81	
3	3	7 1/2	7 1/2	1	—	25	32DP92B1HD*81		32DP92W1HD*81		32DP92F1HD*81		32DP92N1HD*81	
5	5	—	—	1	—	30	32DP92B1HE*81		32DP92W1HE*81		32DP92F1HE*81		32DP92N1HE*81	
—	—	10	10	—	1 3/4	40	32EP92B1HF*81		32EP92W1HF*81		32EP92F1HF*81		32EP92N1HF*81	
7 1/2	7 1/2	—	—	—	1 3/4	50	32EP92B1HG*81		32EP92W1HG*81		32EP92F1HG*81		32EP92N1HG*81	
—	7 1/2	15	20	2	—	40	32FP92B1HH*81		32FP92W1HH*81		32FP92F1HH*81		32FP92N1HH*81	
7 1/2	10	20	—	2	—	50	32FP92B1HJ*81		32FP92W1HJ*81		32FP92F1HJ*81		32FP92N1HJ*81	
—	—	30	30	—	2 1/2	50	32GP92B1HK*81		32GP92W1HK*81		32GP92F1HK*81		32GP92N1HK*81	
10	15	30	40	3	—	50	32HP92B1HM*81		32HP92W1HM*81		32HP92F1HM*81		32HP92N1HM*81	
20	25	40	—	3	—	100	32HP92B1HN*81		32HP92W1HN*81		32HP92F1HN*81		32HP92N1HN*81	
25	30	50	50	—	3 1/2	125	32IP92B1HP*81		32IP92W1HP*81		32IP92F1HP*81		32IP92N1HP*81	
30	40	75	75	4	—	150	32JP92B1HR*81		32JP92W1HR*81		32JP92F1HR*81		32JP92N1HR*81	

Note: Hp's shown above are based on the overload amp range for the FLA's (per the National Electric Code) of typical industrial motors. All starter sizes carry one maximum Hp rating.

① Dual voltage coils not available in modified starters.
 ② For conduit hubs and conversion instructions, see page 9/110.

Features and Benefits

General

Siemens manufactures the three commonly used electromechanical reduced voltage starters. Each one is designed for specific application requirements and consists of auto transformer, wye-delta and partwinding starters.

The reduced voltage starter:

- Reduces inrush current
- Provides smoother acceleration of the load
- Reduces starting torque
- Reduces stresses on mechanical linkages

Combination and non-combination reduced voltage starter sizes range from 0 to 6 including Siemens exclusive motormatched half-sizes. Enclosure types include 1, 3R/12, 4 painted and 4/4X stainless steel. UL listed file #E14900 (class 36); file #E185287 (class 37). CSA certified file #LR 6535 (class 36 & 37).

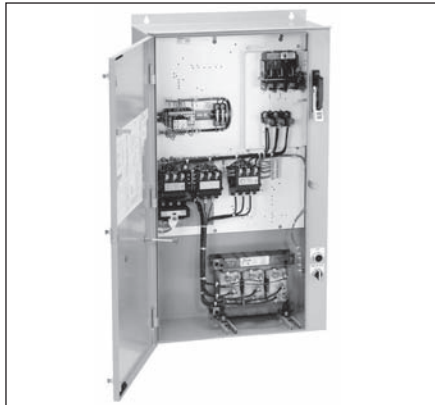

Auto Transformer Starter

- Maximum torque per amp
- Three coil auto transformer for balanced starting currents
- 50, 65 and 80% voltage taps
- Closed circuit transition
- Adjustable starting time
- Solid-state OLR overload as standard
- CPT supplied as standard
- Wide range of factory modifications



Wye-Delta Starter

- Lowest starting torque
- Closed or open circuit transition
- Adjustable starting time
- Solid-state OLR overload as standard
- CPT supplied as standard
- Wide range of factory modifications



Part-Winding Starter

- Simplest design – most economical
- Adjustable starting time
- Solid-state OLR overload as standard
- CPT supplied as standard
- Wide range of factory modifications

Various Methods of Electro-Mechanical Reduced Voltage Motor Starting – A General Comparison

Characteristic	Autotransformer			Part-Winding	Wye-Delta
	50% Tap	65% Tap	80% Tap	2 step	
Starting current drawn from line as % of that which would be drawn upon full voltage starting	25%	42%	64%	65%	33%
Starting current drawn by the motor	50%	65%	80%	65%	58%
Starting torque developed as % of that which would be developed on full voltage starting	25%	42%	64%	40%	33%
Smoothness of acceleration	First in order of Smoothness			Third in order of Smoothness	Second in order of Smoothness
Allowable accelerating times (typical)	15 seconds at 200HP max. or 30 seconds on 200HP based on NEMA medium duty transformers			5 seconds max. Limited by motor design	5-60 seconds Limited by motor design
Starting current and torque and adjustments	Adjustable within limits of various taps			Fixed	Fixed

Auto Transformer with Solid State Overload, Class 36 & 37

Selection

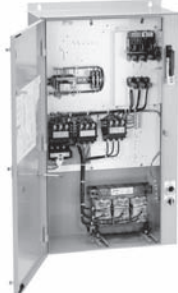
	Ordering Information	Coil and Control Voltage
	Field Modification Kits see page 9/104. Factory Modifications see page 9/119. Dimensions see page 9/167. Wiring Diagrams see page 9/181. Replacement Parts see page 9/131.	The coil voltage will always match the motor voltage. As standard, a CPT is supplied and 120V control voltage is utilized. To change to 120V voltage (CPT not supplied), change the 9th character to "F". To change to 24VAC voltage (CPT not supplied), change the 9th character to "J".

NEMA 1 General Purpose Enclosures

Motor Voltage	Max Hp	NEMA Size (1/2 Size)	Overload Relay		Non-Combination		Combination Non-Fusible Disconnect			Combination Fusible Disconnect			Combination Circuit Breaker		
			Amp Range	Frame Size	Catalog Number	List Price \$	Disc. Amp Rating	Catalog Number	List Price \$	Fuse Clip Amp/Volt Rating	Catalog Number	List Price \$	Circuit Breaker Amps	Catalog Number	List Price \$
200	10	(1¼)	10-40	A1	36EJET6BD		60	37EJET6BDD		60A/250V	37EJET6BDF		50	37EJET6BDP	
	10	2	13-52	B	36FUFT6BD		60	37FUFT6BDD		60A/250V	37FUFT6BDF		50	37FUFT6BDP	
	15	(2½)	25-100	B	36GUGT6BD		100	37GUGT6BDD		100A/250V	37GUGT6BDF		100	37GUGT6BDP	
	25	3	25-100	B	36HUGT6BD		100	37HUGT6BDD		100A/250V	37HUGT6BDF		100	37HUGT6BDP	
	30	(3½)	50-200	B	36IUHT6BD		200	37IUHT6BDD		200A/250V	37IUHT6BDF		125	37IUHT6BDP	
	40	4	50-200	B	36JUHT6BD		200	37JUHT6BDD		200A/250V	37JUHT6BDF		150	37JUHT6BDP	
	50	5	55-250	—	—	—	—	—	—	—	—	—	250	37LPST6BDP	
	75	5	55-250	—	—	36LPUT6BD		400	37LPUT6BDD		400A/250V	37LPUT6BDF		400	37LPUT6BDP
150	6	160-630	—	—	36MPXT6BD		600	37MPXT6BDD		600A/250V	37MPXT6BDF		600	37MPXT6BDP	
230	10	(1¼)	10-40	A1	36EJET2BG		60	37EJET2BGD		60A/250V	37EJET2BGF		50	37EJET2BGP	
	15	2	13-52	B	36FUFT2BG		60	37FUFT2BGD		60A/250V	37FUFT2BGF		50	37FUFT2BGP	
	20	(2½)	25-100	B	36GUGT2BG		100	37GUGT2BGD		100A/250V	37GUGT2BGF		100	37GUGT2BGP	
	30	3	25-100	B	36HUGT2BG		100	37HUGT2BGD		100A/250V	37HUGT2BGF		100	37HUGT2BGP	
	40	(3½)	50-200	B	36IUHT2BG		200	37IUHT2BGD		200A/250V	37IUHT2BGF		125	37IUHT2BGP	
	50	4	50-200	B	36JUHT2BG		200	37JUHT2BGD		200A/250V	37JUHT2BGF		150	37JUHT2BGP	
	75	5	55-250	—	—	—	—	—	—	—	—	—	250	37LPST2BGP	
	100	5	55-250	—	—	36LPUT2BG		400	37LPUT2BGD		400A/250V	37LPUT2BGF		400	37LPUT2BGP
200	6	160-630	—	—	36MPXT2BG		600	37MPXT2BGD		600A/250V	37MPXT2BGF		600	37MPXT2BGP	
460	15	(1¼)	10-40	A1	36EJET4BH		60	37EJET4BHD		60A/600V	37EJET4BHF		50	37EJET4BHP	
	25	2	13-52	B	36FUFT4BH		60	37FUFT4BHD		60A/600V	37FUFT4BHF		50	37FUFT4BHP	
	30	(2½)	13-52	B	36GUGT4BH		100	37GUGT4BHD		100A/600V	37GUGT4BHF		100	37GUGT4BHP	
	50	3	25-100	B	36HUGT4BH		100	37HUGT4BHD		100A/600V	37HUGT4BHF		100	37HUGT4BHP	
	75	(3½)	50-200	B	36IUHT4BH		200	37IUHT4BHD		200A/600V	37IUHT4BHF		125	37IUHT4BHP	
	100	4	50-200	B	36JUHT4BH		200	37JUHT4BHD		200A/600V	37JUHT4BHF		150	37JUHT4BHP	
	150	5	55-250	—	—	—	—	—	—	—	—	—	250	37LPST4BHP	
	200	5	55-250	—	—	36LPUT4BH		400	37LPUT4BHD		400A/600V	37LPUT4BHF		400	37LPUT4BHP
400	6	160-630	—	—	36MPXT4BH		600	37MPXT4BHD		600A/600V	37MPXT4BHF		600	37MPXT4BHP	
575	15	(1¼)	10-40	A1	36EJET5BE		60	37EJET5BED		60A/600V	37EJET5BEF		50	37EJET5BEP	
	25	2	13-52	B	36FUFT5BE		60	37FUFT5BED		60A/600V	37FUFT5BEF		50	37FUFT5BEP	
	30	(2½)	13-52	B	36GUGT5BE		100	37GUGT5BED		100A/600V	37GUGT5BEF		100	37GUGT5BEP	
	50	3	25-100	B	36HUGT5BE		100	37HUGT5BED		100A/600V	37HUGT5BEF		100	37HUGT5BEP	
	75	(3½)	50-200	B	36IUHT5BE		200	37IUHT5BED		200A/600V	37IUHT5BEF		125	37IUHT5BEP	
	100	4	50-200	B	36JUHT5BE		200	37JUHT5BED		200A/600V	37JUHT5BEF		150	37JUHT5BEP	
	150	5	55-250	—	—	—	—	—	—	—	—	—	250	37LPST5BEP	
	200	5	55-250	—	—	36LPUT5BE		400	37LPUT5BED		400A/600V	37LPUT5BEF		400	37LPUT5BEP
400	6	160-630	—	—	36MPXT5BE		600	37MPXT5BED		600A/600V	37MPXT5BEF		600	37MPXT5BEP	

Note: All starter sizes carry one maximum Hp rating (per the National Electric Code).

Auto Transformer with Solid State Overload, Class 36 & 37

Selection

	Ordering Information	Coil and Control Voltage
	<p>Field Modification Kits see page 9/104. Factory Modifications see page 9/119. Dimensions see page 9/167. Wiring Diagrams see page 9/181. Replacement Parts see page 9/131.</p>	<p>The coil voltage will always match the motor voltage. As standard, a CPT is supplied and 120V control voltage is utilized. To change to 120V voltage (CPT not supplied), change the 9th character to "F". To change to 24VAC voltage (CPT not supplied), change the 9th character to "J".</p>

NEMA 4 Painted Enclosures

Motor Voltage	Max Hp	NEMA Size (1/2 Size)	Overload Relay		Non-Combination		Combination Non-Fusible Disconnect			Combination Fusible Disconnect			Combination Circuit Breaker		
			Amp Range	Frame Size	Catalog Number	List Price \$	Disc. Amp Rating	Catalog Number	List Price \$	Fuse Clip Amp/Volt Rating	Catalog Number	List Price \$	Circuit Breaker Amps	Catalog Number	List Price \$
200	10	(1¼)	10-40	A1	36EUT6ED		60	37EUT6EDD		60A/250V	37EUT6EDF		50	37EUT6EDP	
	10	2	13-52	B	36FUF6ED		60	37FUF6EDD		60A/250V	37FUF6EDF		50	37FUF6EDP	
	15	(2½)	25-100	B	36GUG6ED		100	37GUG6EDD		100A/250V	37GUG6EDF		100	37GUG6EDP	
	25	3	25-100	B	36HUG6ED		100	37HUG6EDD		100A/250V	37HUG6EDF		100	37HUG6EDP	
	30	(3½)	50-200	B	36IUH6ED		200	37IUH6EDD		200A/250V	37IUH6EDF		125	37IUH6EDP	
	40	4	50-200	B	36JUHT6ED		200	37JUHT6EDD		200A/250V	37JUHT6EDF		150	37JUHT6EDP	
	50	5	55-250	—	—		—	—		—	—		250	37LPST6EDP	
	75	5	55-250	—	—	36LPUT6ED		400	37LPUT6EDD		400A/250V	37LPUT6EDF		400	37LPUT6EDP
150	6	160-630	—	—	36MPXT6ED		600	37MPXT6EDD		600A/250V	37MPXT6EDF		600	37MPXT6EDP	
230	10	(1¼)	10-40	A1	36EUT2EG		60	37EUT2EGD		60A/250V	37EUT2EGF		50	37EUT2EGP	
	15	2	13-52	B	36FUF2EG		60	37FUF2EGD		60A/250V	37FUF2EGF		50	37FUF2EGP	
	20	(2½)	25-100	B	36GUG2EG		100	37GUG2EGD		100A/250V	37GUG2EGF		100	37GUG2EGP	
	30	3	25-100	B	36HUG2EG		100	37HUG2EGD		100A/250V	37HUG2EGF		100	37HUG2EGP	
	40	(3½)	50-200	B	36IUH2EG		200	37IUH2EGD		200A/250V	37IUH2EGF		125	37IUH2EGP	
	50	4	50-200	B	36JUHT2EG		200	37JUHT2EGD		200A/250V	37JUHT2EGF		150	37JUHT2EGP	
	75	5	55-250	—	—		—	—		—	—		250	37LPST2EGP	
	100	5	55-250	—	—	36LPUT2EG		400	37LPUT2EGD		400A/250V	37LPUT2EGF		400	37LPUT2EGP
200	6	160-630	—	—	36MPXT2EG		600	37MPXT2EGD		600A/250V	37MPXT2EGF		600	37MPXT2EGP	
460	15	(1¼)	10-40	A1	36EUT4EH		60	37EUT4EHD		60A/600V	37EUT4EHF		50	37EUT4EHP	
	25	2	13-52	B	36FUF4EH		60	37FUF4EHD		60A/600V	37FUF4EHF		50	37FUF4EHP	
	30	(2½)	13-52	B	36GUG4EH		100	37GUG4EHD		100A/600V	37GUG4EHF		100	37GUG4EHP	
	50	3	25-100	B	36HUG4EH		100	37HUG4EHD		100A/600V	37HUG4EHF		100	37HUG4EHP	
	75	(3½)	50-200	B	36IUH4EH		200	37IUH4EHD		200A/600V	37IUH4EHF		125	37IUH4EHP	
	100	4	50-200	B	36JUHT4EH		200	37JUHT4EHD		200A/600V	37JUHT4EHF		150	37JUHT4EHP	
	150	5	55-250	—	—		—	—		—	—		250	37LPST4EHP	
	200	5	55-250	—	—	36LPUT4EH		400	37LPUT4EHD		400A/600V	37LPUT4EHF		400	37LPUT4EHP
400	6	160-630	—	—	36MPXT4EH		600	37MPXT4EHD		600A/600V	37MPXT4EHF		600	37MPXT4EHP	
575	15	(1¼)	10-40	A1	36EUT5EE		60	37EUT5EED		60A/600V	37EUT5EEF		50	37EUT5EEP	
	25	2	13-52	B	36FUF5EE		60	37FUF5EED		60A/600V	37FUF5EEF		50	37FUF5EEP	
	30	(2½)	13-52	B	36GUG5EE		100	37GUG5EED		100A/600V	37GUG5EEF		100	37GUG5EEP	
	50	3	25-100	B	36HUG5EE		100	37HUG5EED		100A/600V	37HUG5EEF		100	37HUG5EEP	
	75	(3½)	50-200	B	36IUH5EE		200	37IUH5EED		200A/600V	37IUH5EEF		125	37IUH5EEP	
	100	4	50-200	B	36JUHT5EE		200	37JUHT5EED		200A/600V	37JUHT5EEF		150	37JUHT5EEP	
	150	5	55-250	—	—		—	—		—	—		250	37LPST5EEP	
	200	5	55-250	—	—	36LPUT5EE		400	37LPUT5EED		400A/600V	37LPUT5EEF		400	37LPUT5EEP
400	6	160-630	—	—	36MPXT5EE		600	37MPXT5EED		600A/600V	37MPXT5EEF		600	37MPXT5EEP	

Note: All starter sizes carry one maximum Hp rating (per the National Electric Code).

Auto Transformer with Solid State Overload, Class 36 & 37

Selection

	Ordering Information	Coil and Control Voltage
	<p>Field Modification Kits see page 9/104. Factory Modifications see page 9/119. Dimensions see page 9/167. Wiring Diagrams see page 9/181. Replacement Parts see page 9/131.</p>	<p>The coil voltage will always match the motor voltage. As standard, a CPT is supplied and 120V control voltage is utilized. To change to 120V voltage (CPT not supplied), change the 9th character to "F". To change to 24VAC voltage (CPT not supplied), change the 9th character to "J".</p>

NEMA 4/4X Stainless Steel Enclosures

Motor Voltage	Max Hp	NEMA Size (1/2 Size)	Overload Relay		Non-Combination		Combination Non-Fusible Disconnect			Combination Fusible Disconnect			Combination Circuit Breaker		
			Amp Range	Frame Size	Catalog Number	List Price \$	Disc. Amp Rating	Catalog Number	List Price \$	Fuse Clip Amp/Volt Rating	Catalog Number	List Price \$	Circuit Breaker Amps	Catalog Number	List Price \$
200	10	(1¼)	10-40	A1	36EUET6WD		60	37EUET6WDD		60A/250V	37EUET6WDF		50	37EUET6WDP	
	10	2	13-52	B	36FUFT6WD		60	37FUFT6WDD		60A/250V	37FUFT6WDF		50	37FUFT6WDP	
	15	(2½)	25-100	B	36GUGT6WD		100	37GUGT6WDD		100A/250V	37GUGT6WDF		100	37GUGT6WDP	
	25	3	25-100	B	36HUGT6WD		100	37HUGT6WDD		100A/250V	37HUGT6WDF		100	37HUGT6WDP	
	30	(3½)	50-200	B	36IUHT6WD		200	37IUHT6WDD		200A/250V	37IUHT6WDF		125	37IUHT6WDP	
	40	4	50-200	B	36JUHT6WD		200	37JUHT6WDD		200A/250V	37JUHT6WDF		150	37JUHT6WDP	
230	10	(1¼)	10-40	A1	36EUET2WG		60	37EUET2WGD		60A/250V	37EUET2WGF		50	37EUET2WGP	
	15	2	13-52	B	36FUFT2WG		60	37FUFT2WGD		60A/250V	37FUFT2WGF		50	37FUFT2WGP	
	20	(2½)	25-100	B	36GUGT2WG		100	37GUGT2WGD		100A/250V	37GUGT2WGF		100	37GUGT2WGP	
	30	3	25-100	B	36HUGT2WG		100	37HUGT2WGD		100A/250V	37HUGT2WGF		100	37HUGT2WGP	
	40	(3½)	50-200	B	36IUHT2WG		200	37IUHT2WGD		200A/250V	37IUHT2WGF		125	37IUHT2WGP	
	50	4	50-200	B	36JUHT2WG		200	37JUHT2WGD		200A/250V	37JUHT2WGF		150	37JUHT2WGP	
460	15	(1¼)	10-40	A1	36EUET4WH		60	37EUET4WHD		60A/600V	37EUET4WHF		50	37EUET4WHP	
	25	2	13-52	B	36FUFT4WH		60	37FUFT4WHD		60A/600V	37FUFT4WHF		50	37FUFT4WHP	
	30	(2½)	13-52	B	36GUGT4WH		100	37GUGT4WHD		100A/600V	37GUGT4WHF		100	37GUGT4WHP	
	50	3	25-100	B	36HUGT4WH		100	37HUGT4WHD		100A/600V	37HUGT4WHF		100	37HUGT4WHP	
	75	(3½)	50-200	B	36IUHT4WH		200	37IUHT4WHD		200A/600V	37IUHT4WHF		125	37IUHT4WHP	
	100	4	50-200	B	36JUHT4WH		200	37JUHT4WHD		200A/600V	37JUHT4WHF		150	37JUHT4WHP	
575	15	(1¼)	10-40	A1	36EUET5WE		60	37EUET5WED		60A/600V	37EUET5WEF		50	37EUET5WEP	
	25	2	13-52	B	36FUFT5WE		60	37FUFT5WED		60A/600V	37FUFT5WEF		50	37FUFT5WEP	
	30	(2½)	13-52	B	36GUGT5WE		100	37GUGT5WED		100A/600V	37GUGT5WEF		100	37GUGT5WEP	
	50	3	25-100	B	36HUGT5WE		100	37HUGT5WED		100A/600V	37HUGT5WEF		100	37HUGT5WEP	
	75	(3½)	50-200	B	36IUHT5WE		200	37IUHT5WED		200A/600V	37IUHT5WEF		125	37IUHT5WEP	
	100	4	50-200	B	36JUHT5WE		200	37JUHT5WED		200A/600V	37JUHT5WEF		150	37JUHT5WEP	

Note: All starter sizes carry one maximum Hp rating (per the National Electric Code).

Auto Transformer with Solid State Overload, Class 36 & 37

Selection

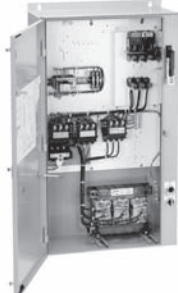
	Ordering Information Field Modification Kits see page 9/104. Factory Modifications see page 9/119. Dimensions see page 9/167. Wiring Diagrams see page 9/181. Replacement Parts see page 9/131.	Coil and Control Voltage The coil voltage will always match the motor voltage. As standard, a CPT is supplied and 120V control voltage is utilized. To change to 120V voltage (CPT not supplied), change the 9th character to "F". To change to 24VAC voltage (CPT not supplied), change the 9th character to "J".

NEMA 12 Enclosures (Supplied as NEMA 12, field convertible to 3/3R)^①

Motor Voltage	Max Hp	NEMA Size (1/2 Size)	Overload Relay		Non-Combination		Combination Non-Fusible Disconnect			Combination Fusible Disconnect			Combination Circuit Breaker		
			Amp Range	Frame Size	Catalog Number	List Price \$	Disc. Amp Rating	Catalog Number	List Price \$	Fuse Clip Amp/Volt Rating	Catalog Number	List Price \$	Circuit Breaker Amps	Catalog Number	List Price \$
200	10	(1¼)	10-40	A1	36EUET6ND		60	37EUET6NDD		60A/250V	37EUET6NDF		50	37EUET6NDP	
	10	2	13-52	B	36FUFT6ND		60	37FUFT6NDD		60A/250V	37FUFT6NDF		50	37FUFT6NDP	
	15	(2½)	25-100	B	36GUGT6ND		100	37GUGT6NDD		100A/250V	37GUGT6NDF		100	37GUGT6NDP	
	25	3	25-100	B	36HUGT6ND		100	37HUGT6NDD		100A/250V	37HUGT6NDF		100	37HUGT6NDP	
	30	(3½)	50-200	B	36IUHT6ND		200	37IUHT6NDD		200A/250V	37IUHT6NDF		125	37IUHT6NDP	
	40	4	50-200	B	36JUHT6ND		200	37JUHT6NDD		200A/250V	37JUHT6NDF		150	37JUHT6NDP	
	50	5	55-250	—	—		—	—		—	—		250	37LPST6NDP	
	75	5	55-250	—	—	36LPUT6ND		400	37LPUT6NDD		400A/250V	37LPUT6NDF		400	37LPUT6NDP
150	6	160-630	—	—	36MPXT6ND		600	37MPXT6NDD		600A/250V	37MPXT6NDF		600	37MPXT6NDP	
230	10	(1¼)	10-40	A1	36EUET2NG		60	37EUET2NGD		60A/250V	37EUET2NGF		50	37EUET2NGP	
	15	2	13-52	B	36FUFT2NG		60	37FUFT2NGD		60A/250V	37FUFT2NGF		50	37FUFT2NGP	
	20	(2½)	25-100	B	36GUGT2NG		100	37GUGT2NGD		100A/250V	37GUGT2NGF		100	37GUGT2NGP	
	30	3	25-100	B	36HUGT2NG		100	37HUGT2NGD		100A/250V	37HUGT2NGF		100	37HUGT2NGP	
	40	(3½)	50-200	B	36IUHT2NG		200	37IUHT2NGD		200A/250V	37IUHT2NGF		125	37IUHT2NGP	
	50	4	50-200	B	36JUHT2NG		200	37JUHT2NGD		200A/250V	37JUHT2NGF		150	37JUHT2NGP	
	75	5	55-250	—	—		—	—		—	—		250	37LPST2NGP	
	100	5	55-250	—	—	36LPUT2NG		400	37LPUT2NGD		400A/250V	37LPUT2NGF		400	37LPUT2NGP
200	6	160-630	—	—	36MPXT2NG		600	37MPXT2NGD		600A/250V	37MPXT2NGF		600	37MPXT2NGP	
460	15	(1¼)	10-40	A1	36EUET4NH		60	37EUET4NHD		60A/600V	37EUET4NHF		50	37EUET4NHP	
	25	2	13-52	B	36FUFT4NH		60	37FUFT4NHD		60A/600V	37FUFT4NHF		50	37FUFT4NHP	
	30	(2½)	13-52	B	36GUGT4NH		100	37GUGT4NHD		100A/600V	37GUGT4NHF		100	37GUGT4NHP	
	50	3	25-100	B	36HUGT4NH		100	37HUGT4NHD		100A/600V	37HUGT4NHF		100	37HUGT4NHP	
	75	(3½)	50-200	B	36IUHT4NH		200	37IUHT4NHD		200A/600V	37IUHT4NHF		125	37IUHT4NHP	
	100	4	50-200	B	36JUHT4NH		200	37JUHT4NHD		200A/600V	37JUHT4NHF		150	37JUHT4NHP	
	150	5	55-250	—	—		—	—		—	—		250	37LPST4NHP	
	200	5	55-250	—	—	36LPUT4NH		400	37LPUT4NHD		400A/600V	37LPUT4NHF		400	37LPUT4NHP
400	6	160-630	—	—	36MPXT4NH		600	37MPXT4NHD		600A/600V	37MPXT4NHF		600	37MPXT4NHP	
575	15	(1¼)	10-40	A1	36EUET5NE		60	37EUET5NED		60A/600V	37EUET5NEF		50	37EUET5NEP	
	25	2	13-52	B	36FUFT5NE		60	37FUFT5NED		60A/600V	37FUFT5NEF		50	37FUFT5NEP	
	30	(2½)	13-52	B	36GUGT5NE		100	37GUGT5NED		100A/600V	37GUGT5NEF		100	37GUGT5NEP	
	50	3	25-100	B	36HUGT5NE		100	37HUGT5NED		100A/600V	37HUGT5NEF		100	37HUGT5NEP	
	75	(3½)	50-200	B	36IUHT5NE		200	37IUHT5NED		200A/600V	37IUHT5NEF		125	37IUHT5NEP	
	100	4	50-200	B	36JUHT5NE		200	37JUHT5NED		200A/600V	37JUHT5NEF		150	37JUHT5NEP	
	150	5	55-250	—	—		—	—		—	—		250	37LPST5NEP	
	200	5	55-250	—	—	36LPUT5NE		400	37LPUT5NED		400A/600V	37LPUT5NEF		400	37LPUT5NEP
400	6	160-630	—	—	36MPXT5NE		600	37MPXT5NED		600A/600V	37MPXT5NEF		600	37MPXT5NEP	

Note: All starter sizes carry one maximum Hp rating (per the National Electric Code).

① See page 9/110 for conduit hubs and conversion instructions.

2 Step Part Winding with Solid State Overload, Class 36 & 37

Selection

	Ordering Information	Coil and Control Voltage
	<p>Field Modification Kits see page 9/104. Factory Modifications see page 9/119. Dimensions see page page 9/167. Wiring Diagrams see page 9/180. Replacement Parts see page 9/131.</p>	<p>The coil voltage will always match the motor voltage. As standard, a CPT is supplied and 120V control voltage is utilized. To change to 120V voltage (CPT not supplied), change the 9th character to "F". To change to 24VAC voltage (CPT not supplied), change the 9th character to "J".</p>

NEMA 1 General Purpose Enclosures

Motor Voltage	Max Hp	NEMA Size (1/2 Size)	Overload Relay		Non-Combination		Combination Non-Fusible Disconnect		Combination Fusible Disconnect			Combination Circuit Breaker		
			Amp Range	Frame Size	Catalog Number	List Price \$	Disc. Amp Rating	Catalog Number	List Price \$	Fuse Clip Amp/Volt Rating	Catalog Number	List Price \$	Circuit Breaker Amps	Catalog Number
200	7½	0	5.5-22	A1	36CUDP6BD		60	37CUDP6BDD		60A/250V	37CUDP6BDF	30	37CUDP6BDP	
	10	1	5.5-22	A1	36DUDP6BD		60	37DUDP6BDD		60A/250V	37DUDP6BDF	50	37DUDP6BDP	
	15	(1¼)	10-40	A1	36EUEP6BD		100	37EUEP6BDD		100A/250V	37EUEP6BDF	100	37EUEP6BDP	
	20	2	13-52	B	36FUF6BD		100	37FUF6BDD		100A/250V	37FUF6BDF	100	37FUF6BDP	
	30	(2½)	25-100	B	36GUGP6BD		200	37GUGP6BDD		200A/250V	37GUGP6BDF	125	37GUGP6BDP	
	40	3	25-100	B	36HUGP6BD		200	37HUGP6BDD		200A/250V	37HUGP6BDF	150	37HUGP6BDP	
	50	(3½)	50-200	B	36IUHP6BD		200	37IUHP6BDD		200A/250V	37IUHP6BDF	250	37IUHP6BDP	
	75	4	50-200	B	36JUHP6BD		400	37JUHP6BDD		400A/250V	37JUHP6BDF	400	37JUHP6BDP	
100	5	55-250	—	—	—	—	—	—	—	—	600	37LSP6BDP		
150	5	55-250	—	—	36LPUP6BD		600	37LPUP6BDD		600A/250V	37LPUP6BDF	600	37LPUP6BDP	
230	7½	0	5.5-22	A1	36CUDP2BG		60	37CUDP2BGD		60A/250V	37CUDP2BGF	30	37CUDP2BGP	
	10	1	5.5-22	A1	36DUDP2BG		60	37DUDP2BGD		60A/250V	37DUDP2BGF	50	37DUDP2BGP	
	20	(1½)	10-40	A1	36EUEP2BG		100	37EUEP2BGD		100A/250V	37EUEP2BGF	100	37EUEP2BGP	
	25	2	13-52	B	36FUF2BG		100	37FUF2BGD		100A/250V	37FUF2BGF	100	37FUF2BGP	
	30	(2½)	25-100	B	36GUGP2BG		200	37GUGP2BGD		200A/250V	37GUGP2BGF	100	37GUGP2BGP	
	50	3	25-100	B	36HUGP2BG		200	37HUGP2BGD		200A/250V	37HUGP2BGF	150	37HUGP2BGP	
	60	(3½)	50-200	B	36IUHP2BG		200	37IUHP2BGD		200A/250V	37IUHP2BGF	250	37IUHP2BGP	
	75	4	50-200	B	36JUHP2BG		400	37JUHP2BGD		400A/250V	37JUHP2BGF	250	37JUHP2BGP	
125	5	55-250	—	—	—	—	—	—	—	—	400	37LSP2BGP		
150	5	55-250	—	—	36LPUP2BG		600	37LPUP2BGD		600A/250V	37LPUP2BGF	600	37LPUP2BGP	
300	6	160-630	—	—	36MPXP2BG		1200	37MPXP2BGD		1200A/250V	37MPXP2BGF	1200	37MPXP2BGP	
460	10	0	5.5-22	A1	36CUDP4BH		30	37CUDP4BHD		30A/600V	37CUDP4BHF	30	37CUDP4BHP	
	15	1	5.5-22	A1	36DUDP4BH		60	37DUDP4BHD		60A/600V	37DUDP4BHF	30	37DUDP4BHP	
	30	(1¼)	10-40	A1	36EUEP4BH		60	37EUEP4BHD		60A/600V	37EUEP4BHF	50	37EUEP4BHP	
	40	2	13-52	B	36FUF4BH		100	37FUF4BHD		100A/600V	37FUF4BHF	100	37FUF4BHP	
	60	(2½)	25-100	B	36GUGP4BH		200	37GUGP4BHD		200A/600V	37GUGP4BHF	100	37GUGP4BHP	
	75	3	25-100	B	36HUGP4BH		200	37HUGP4BHD		200A/600V	37HUGP4BHF	125	37HUGP4BHP	
	100	(3½)	50-200	B	36IUHP4BH		200	37IUHP4BHD		200A/600V	37IUHP4BHF	150	37IUHP4BHP	
	150	4	50-200	B	36JUHP4BH		400	37JUHP4BHD		400A/600V	37JUHP4BHF	250	37JUHP4BHP	
250	5	55-250	—	—	—	—	—	—	—	—	400	37LSP4BHP		
350	5	55-250	—	—	36LPUP4BH		600	37LPUP4BHD		600A/600V	37LPUP4BHF	600	37LPUP4BHP	
600	6	160-630	—	—	36MPXP4BH		1200	37MPXP4BHD		1200A/600V	37MPXP4BHF	1200	37MPXP4BHP	
575	10	0	5.5-22	A1	36CUDP5BE		30	37CUDP5BED		30A/600V	37CUDP5BEF	30	37CUDP5BEP	
	15	1	5.5-22	A1	36DUDP5BE		60	37DUDP5BED		60A/600V	37DUDP5BEF	30	37DUDP5BEP	
	30	(1¼)	10-40	A1	36EUEP5BE		60	37EUEP5BED		60A/600V	37EUEP5BEF	50	37EUEP5BEP	
	40	2	13-52	B	36FUF5BE		60	37FUF5BED		60A/600V	37FUF5BEF	50	37FUF5BEP	
	60	(2½)	25-100	B	36GUGP5BE		100	37GUGP5BED		100A/600V	37GUGP5BEF	100	37GUGP5BEP	
	75	3	25-100	B	36HUGP5BE		200	37HUGP5BED		200A/600V	37HUGP5BEF	125	37HUGP5BEP	
	100	(3½)	50-200	B	36IUHP5BE		400	37IUHP5BED		400A/600V	37IUHP5BEF	150	37IUHP5BEP	
	150	4	50-200	B	36JUHP5BE		400	37JUHP5BED		400A/600V	37JUHP5BEF	250	37JUHP5BEP	
250	5	55-250	—	—	—	—	—	—	—	—	—	—	—	
350	5	55-250	—	—	36LPUP5BE		600	37LPUP5BED		600A/600V	37LPUP5BEF	400	37LPUP5BEP	
600	6	160-630	—	—	36MPXP5BE		1200	37MPXP5BED		1200A/600V	37MPXP5BEF	1200	37MPXP5BEP	

Note: All starter sizes carry one maximum Hp rating (per the National Electric Code).

GENERAL PURPOSE CONTROL 9

2 Step Part Winding with Solid State Overload, Class 36 & 37

Selection

	Ordering Information	Coil and Control Voltage
	Field Modification Kits see page 9/104. Factory Modifications see page 9/119. Dimensions see page 9/167. Wiring Diagrams see page 9/180. Replacement Parts see page 9/131.	The coil voltage will always match the motor voltage. As standard, a CPT is supplied and 120V control voltage is utilized. To change to 120V voltage (CPT not supplied), change the 9th character to "F". To change to 24VAC voltage (CPT not supplied), change the 9th character to "J".

NEMA 4 Painted Enclosures

Motor Voltage	Max Hp	NEMA Size (1/2 Size)	Overload Relay		Non-Combination		Combination Non-Fusible Disconnect			Combination Fusible Disconnect			Combination Circuit Breaker		
			Amp Range	Frame Size	Catalog Number	List Price \$	Disc. Amp Rating	Catalog Number	List Price \$	Fuse Clip Amp/Volt Rating	Catalog Number	List Price \$	Circuit Breaker Amps	Catalog Number	List Price \$
200	7½	0	5.5–22	A1	36CUDP6ED		60	37CUDP6EDD		60A/250V	37CUDP6EDF		30	37CUDP6EDP	
	10	1	5.5–22	A1	36DUDP6ED		60	37DUDP6EDD		60A/250V	37DUDP6EDF		50	37DUDP6EDP	
	15	(1¼)	10–40	A1	36EUEP6ED		100	37EUEP6EDD		100A/250V	37EUEP6EDF		100	37EUEP6EDP	
	20	2	13–52	B	36FUF6ED		100	37FUF6EDD		100A/250V	37FUF6EDF		100	37FUF6EDP	
	30	(2½)	25–100	B	36GUGP6ED		200	37GUGP6EDD		200A/250V	37GUGP6EDF		125	37GUGP6EDP	
	40	3	25–100	B	36HUGP6ED		200	37HUGP6EDD		200A/250V	37HUGP6EDF		150	37HUGP6EDP	
	50	(3½)	50–200	B	36IUHP6ED		200	37IUHP6EDD		200A/250V	37IUHP6EDF		250	37IUHP6EDP	
	75	4	50–200	B	36JUHP6ED		400	37JUHP6EDD		400A/250V	37JUHP6EDF		400	37JUHP6EDP	
	100	5	55–250	—	—	—	—	—	—	—	—	—	600	37LSP6EDP	
150	5	55–250	—	—	36LPUP6ED		600	37LPUP6EDD		600A/250V	37LPUP6EDF		600	37LPUP6EDP	
230	7½	0	5.5–22	A1	36CUDP2EG		60	37CUDP2EGD		60A/250V	37CUDP2EGF		30	37CUDP2EGP	
	10	1	5.5–22	A1	36DUDP2EG		60	37DUDP2EGD		60A/250V	37DUDP2EGF		50	37DUDP2EGP	
	20	(1½)	10–40	A1	36EUEP2EG		100	37EUEP2EGD		100A/250V	37EUEP2EGF		100	37EUEP2EGP	
	25	2	13–52	B	36FUF2EG		100	37FUF2EGD		100A/250V	37FUF2EGF		100	37FUF2EGP	
	30	(2½)	25–100	B	36GUGP2EG		200	37GUGP2EGD		200A/250V	37GUGP2EGF		100	37GUGP2EGP	
	50	3	25–100	B	36HUGP2EG		200	37HUGP2EGD		200A/250V	37HUGP2EGF		150	37HUGP2EGP	
	60	(3½)	50–200	B	36IUHP2EG		200	37IUHP2EGD		200A/250V	37IUHP2EGF		250	37IUHP2EGP	
	75	4	50–200	B	36JUHP2EG		400	37JUHP2EGD		400A/250V	37JUHP2EGF		250	37JUHP2EGP	
	125	5	55–250	—	—	—	—	—	—	—	—	—	400	37LSP2EGP	
150	5	55–250	—	—	36LPUP2EG		600	37LPUP2EGD		600A/250V	37LPUP2EGF		600	37LPUP2EGP	
300	6	160–630	—	—	36MPXP2EG		1200	37MPXP2EGD		1200A/250V	37MPXP2EGF		1200	37MPXP2EGP	
460	10	0	5.5–22	A1	36CUDP4EH		30	37CUDP4EHD		30A/600V	37CUDP4EHF		30	37CUDP4EHP	
	15	1	5.5–22	A1	36DUDP4EH		60	37DUDP4EHD		60A/600V	37DUDP4EHF		30	37DUDP4EHP	
	30	(1¼)	10–40	A1	36EUEP4EH		60	37EUEP4EHD		60A/600V	37EUEP4EHF		50	37EUEP4EHP	
	40	2	13–52	B	36FUF4EH		100	37FUF4EHD		100A/600V	37FUF4EHF		100	37FUF4EHP	
	60	(2½)	25–100	B	36GUGP4EH		200	37GUGP4EHD		200A/600V	37GUGP4EHF		100	37GUGP4EHP	
	75	3	25–100	B	36HUGP4EH		200	37HUGP4EHD		200A/600V	37HUGP4EHF		125	37HUGP4EHP	
	100	(3½)	50–200	B	36IUHP4EH		200	37IUHP4EHD		200A/600V	37IUHP4EHF		150	37IUHP4EHP	
	150	4	50–200	B	36JUHP4EH		400	37JUHP4EHD		400A/600V	37JUHP4EHF		250	37JUHP4EHP	
	250	5	55–250	—	—	—	—	—	—	—	—	—	400	37LSP4EHP	
350	5	55–250	—	—	36LPUP4EH		600	37LPUP4EHD		600A/600V	37LPUP4EHF		600	37LPUP4EHP	
600	6	160–630	—	—	36MPXP4EH		1200	37MPXP4EHD		1200A/600V	37MPXP4EHF		1200	37MPXP4EHP	
575	10	0	5.5–22	A1	36CUDP5EE		30	37CUDP5EED		30A/600V	37CUDP5EEF		30	37CUDP5EEP	
	15	1	5.5–22	A1	36DUDP5EE		60	37DUDP5EED		60A/600V	37DUDP5EEF		30	37DUDP5EEP	
	30	(1¼)	10–40	A1	36EUEP5EE		60	37EUEP5EED		60A/600V	37EUEP5EEF		50	37EUEP5EEP	
	40	2	13–52	B	36FUF5EE		60	37FUF5EED		60A/600V	37FUF5EEF		50	37FUF5EEP	
	60	(2½)	25–100	B	36GUGP5EE		100	37GUGP5EED		100A/600V	37GUGP5EEF		100	37GUGP5EEP	
	75	3	25–100	B	36HUGP5EE		200	37HUGP5EED		200A/600V	37HUGP5EEF		125	37HUGP5EEP	
	100	(3½)	50–200	B	36IUHP5EE		400	37IUHP5EED		400A/600V	37IUHP5EEF		150	37IUHP5EEP	
	150	4	50–200	B	36JUHP5EE		400	37JUHP5EED		400A/600V	37JUHP5EEF		250	37JUHP5EEP	
	250	5	55–250	—	—	—	—	—	—	400A/600V	37LSP5EEF		—	—	
350	5	55–250	—	—	36LPUP5EE		600	37LPUP5EED		600A/600V	37LPUP5EEF		400	37LPUP5EEP	
600	6	160–630	—	—	36MPXP5EE		1200	37MPXP5EED		1200A/600V	37MPXP5EEF		1200	37MPXP5EEP	

Note: All starter sizes carry one maximum Hp rating (per the National Electric Code).

6 GENERAL PURPOSE CONTROL

2 Step Part Winding with Solid State Overload, Class 36 & 37

Selection

	Ordering Information Field Modification Kits see page 9/104. Factory Modifications see page 9/119. Dimensions see page page 9/167. Wiring Diagrams see page 9/180. Replacement Parts see page 9/131.	Coil and Control Voltage The coil voltage will always match the motor voltage. As standard, a CPT is supplied and 120V control voltage is utilized. To change to 120V voltage (CPT not supplied), change the 9th character to "F". To change to 24VAC voltage (CPT not supplied), change the 9th character to "J".

NEMA 4/4X Stainless Steel Enclosures

Motor Voltage	Max Hp	NEMA Size (1/2 Size)	Overload Relay		Non-Combination		Combination Non-Fusible Disconnect			Combination Fusible Disconnect		Combination Circuit Breaker		
			Amp Range	Frame Size	Catalog Number	List Price \$	Disc. Amp Rating	Catalog Number	List Price \$	Fuse Clip Amp/Volt Rating	Catalog Number	Circuit Breaker Amps	Catalog Number	List Price \$
200	7½	0	5.5-22	A1	36CUDP6WD		60	37CUDP6WDD		60A/250V	37CUDP6WDF	30	37CUDP6WDP	
	10	1	5.5-22	A1	36DUDP6WD		60	37DUDP6WDD		60A/250V	37DUDP6WDF	50	37DUDP6WDP	
	15	(1¼)	10-40	A1	36EUEP6WD		100	37EUEP6WDD		100A/250V	37EUEP6WDF	100	37EUEP6WDP	
	20	2	13-52	B	36FUF6WD		100	37FUF6WDD		100A/250V	37FUF6WDF	100	37FUF6WDP	
	30	(2½)	25-100	B	36GUGP6WD		200	37GUGP6WDD		200A/250V	37GUGP6WDF	125	37GUGP6WDP	
	40	3	25-100	B	36HUGP6WD		200	37HUGP6WDD		200A/250V	37HUGP6WDF	150	37HUGP6WDP	
	50	(3½)	50-200	B	36IUHP6WD		200	37IUHP6WDD		200A/250V	37IUHP6WDF	250	37IUHP6WDP	
230	7½	0	5.5-22	A1	36CUDP2WG		60	37CUDP2WGD		60A/250V	37CUDP2WGF	30	37CUDP2WGP	
	10	1	5.5-22	A1	36DUDP2WG		60	37DUDP2WGD		60A/250V	37DUDP2WGF	50	37DUDP2WGP	
	20	(1½)	10-40	A1	36EUEP2WG		100	37EUEP2WGD		100A/250V	37EUEP2WGF	100	37EUEP2WGP	
	25	2	13-52	B	36FUF2WG		100	37FUF2WGD		100A/250V	37FUF2WGF	100	37FUF2WGP	
	30	(2½)	25-100	B	36GUGP2WG		200	37GUGP2WGD		200A/250V	37GUGP2WGF	100	37GUGP2WGP	
	50	3	25-100	B	36HUGP2WG		200	37HUGP2WGD		200A/250V	37HUGP2WGF	150	37HUGP2WGP	
	60	(3½)	50-200	B	36IUHP2WG		200	37IUHP2WGD		200A/250V	37IUHP2WGF	250	37IUHP2WGP	
460	10	0	5.5-22	A1	36CUDP4WH		30	37CUDP4WHD		30A/600V	37CUDP4WHF	30	37CUDP4WHP	
	15	1	5.5-22	A1	36DUDP4WH		60	37DUDP4WHD		60A/600V	37DUDP4WHF	30	37DUDP4WHP	
	30	(1¼)	10-40	A1	36EUEP4WH		60	37EUEP4WHD		60A/600V	37EUEP4WHF	50	37EUEP4WHP	
	40	2	13-52	B	36FUF4WH		100	37FUF4WHD		100A/600V	37FUF4WHF	100	37FUF4WHP	
	60	(2½)	25-100	B	36GUGP4WH		200	37GUGP4WHD		200A/600V	37GUGP4WHF	100	37GUGP4WHP	
	75	3	25-100	B	36HUGP4WH		200	37HUGP4WHD		200A/600V	37HUGP4WHF	125	37HUGP4WHP	
	100	(3½)	50-200	B	36IUHP4WH		200	37IUHP4WHD		200A/600V	37IUHP4WHF	150	37IUHP4WHP	
575	10	0	5.5-22	A1	36CUDP5WE		30	37CUDP5WED		30A/600V	37CUDP5WEF	30	37CUDP5WEP	
	15	1	5.5-22	A1	36DUDP5WE		60	37DUDP5WED		60A/600V	37DUDP5WEF	30	37DUDP5WEP	
	30	(1¼)	10-40	A1	36EUEP5WE		60	37EUEP5WED		60A/600V	37EUEP5WEF	50	37EUEP5WEP	
	40	2	13-52	B	36FUF5WE		60	37FUF5WED		60A/600V	37FUF5WEF	50	37FUF5WEP	
	60	(2½)	25-100	B	36GUGP5WE		100	37GUGP5WED		100A/600V	37GUGP5WEF	100	37GUGP5WEP	
	75	3	25-100	B	36HUGP5WE		200	37HUGP5WED		200A/600V	37HUGP5WEF	125	37HUGP5WEP	
	100	(3½)	50-200	B	36IUHP5WE		400	37IUHP5WED		400A/600V	37IUHP5WEF	150	37IUHP5WEP	
150	4	50-200	B	36JUHP5WE		400	37JUHP5WED		400A/600V	37JUHP5WEF	250	37JUHP5WEP		

Note: All starter sizes carry one maximum Hp rating (per the National Electric Code).